



Freestyle 1025

Combined Cordless Telephone & Digital Answering Machine



User Guide

This equipment is not designed for making emergency telephone calls when the power fails. Alternative arrangements should be made for access to emergency services.

Key features

Digital answer machine

No tape to worry about. Up to a maximum of 14 minutes recording time including your outgoing message. Pre-recorded outgoing messages let you use your Freestyle 1025 straight away with the option of recording your own outgoing message at any time.

Control of the answer machine through the handset

You can use the handset to operate all the functions of the answer machine, including message playback and recording a new outgoing message.

Additional handsets

Up to 3 additional handsets can be added to your Freestyle 1025.

200-metre range*

Your Freestyle 1025 gives you extra freedom around the home with a handset range of up to 200 metres from the base.

*In ideal conditions.

10-number Quickdial memory

Store up to 10 of your most frequently dialled or most important numbers in the memory and dial them by pressing just 2 buttons.

Call screening through the handset

When the answer machine is switched on, you can use the handset to listen to the caller leaving a message.

Either cut in to take the call in person or let your Freestyle 1025 continue recording the message.

3 ringer melodies

You can use your handset to hear and choose between three different ringer melodies for your Freestyle 1025.

8-channel auto-frequency (31-39Mhz)

8 channels and a new frequency range of signals between the handset and base greatly reduce the chance of any interference from another phone.

Please open this page for an 'at a glance' guide to your Freestyle 1025.

Please open this page for a 'further at a glance' guide to your Freestyle 1025.



At a glance

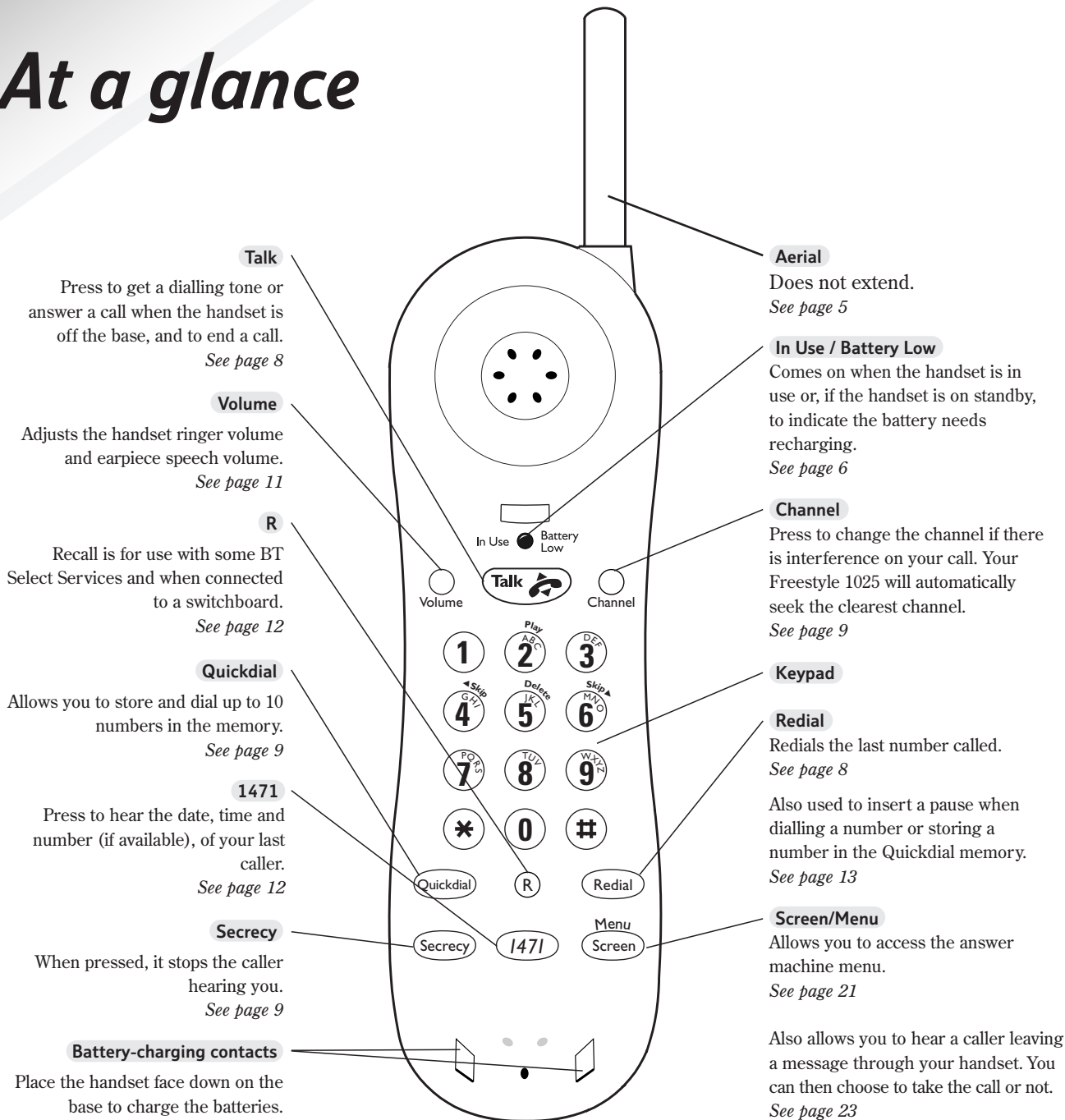

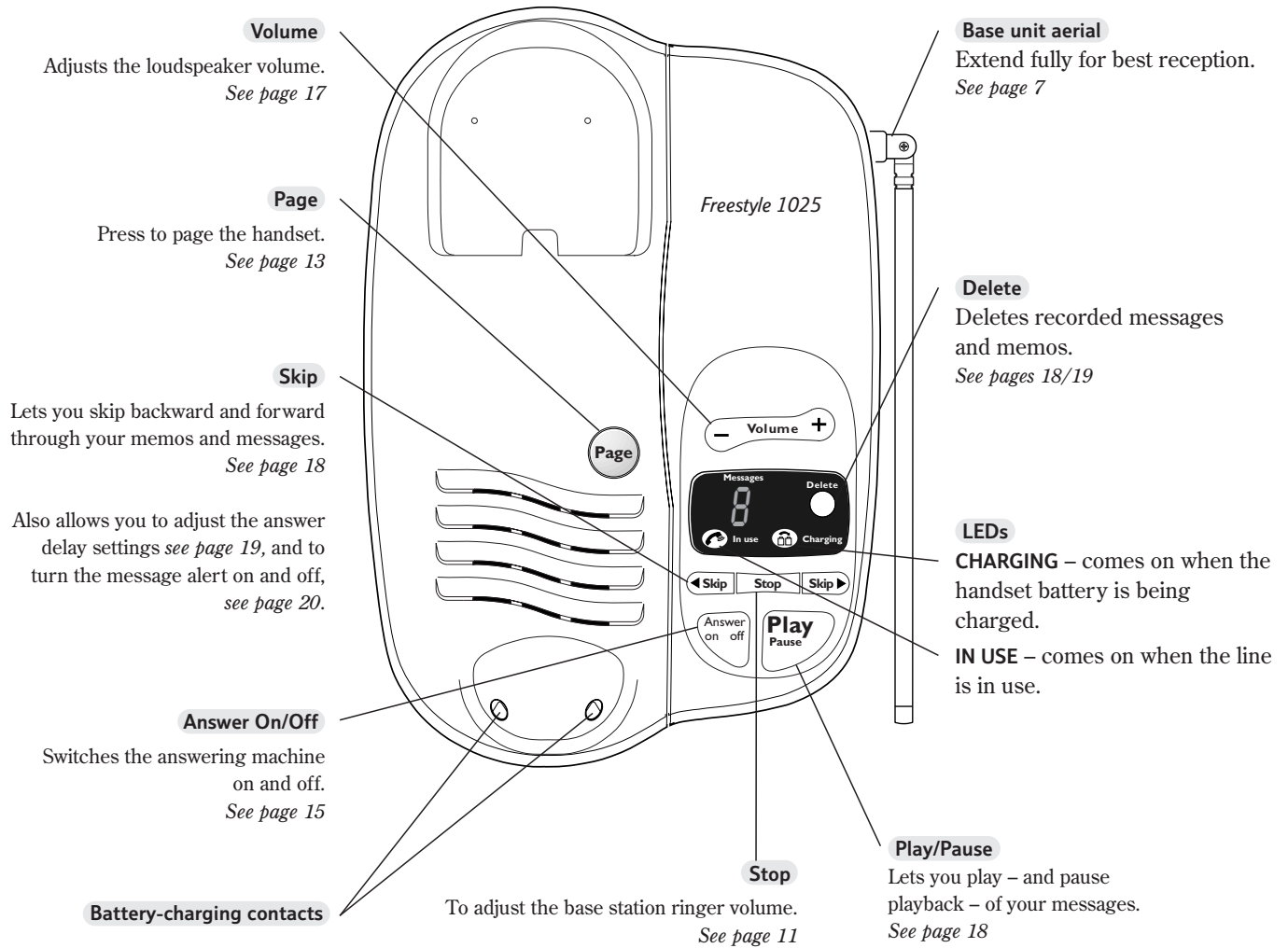

Stop messages being played.
See page 16

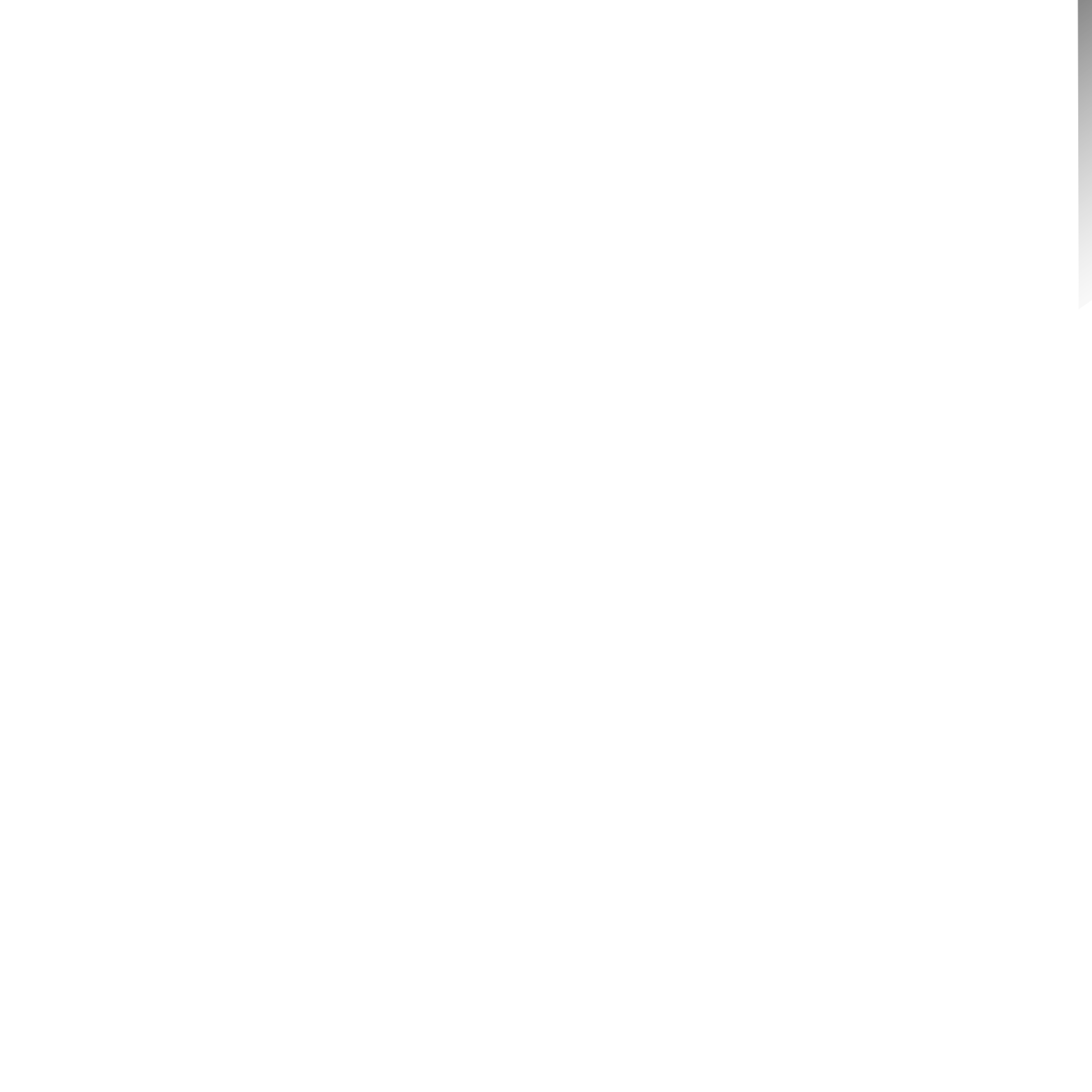

In this guide

<i>At a glance</i>	1	<i>Freestyle 90/130/1025/1200</i>	
<i>Introduction</i>	4	<i>Additional handsets</i>	27
<i>Setting up</i>	5	<i>Registering your handset</i>	27
<i>Using your Freestyle 1025 telephone</i>	8	<i>Basic use of additional Freestyle handsets</i>	29
<i>Making and receiving calls</i>	8	<i>Transferring calls between handsets</i>	29
<i>Using the Quickdial to store and dial numbers</i>	9	<i>Help</i>	30
<i>Call return (1471)</i>	12	<i>Technical information</i>	34
<i>Call waiting</i>	12	<i>Maintenance</i>	36
<i>Using your Freestyle 1025 answering machine</i>	14	<i>Wall mounting</i>	38
<i>Message display on the base station</i>	14	<i>Wall-mounting template</i>	39
<i>Setting up your answer machine</i>	15	<i>Index</i>	40
<i>Incoming messages</i>	17		
<i>Using your answering machine from the base station</i>	18		
<i>Answer delay</i>	19		
<i>Message alert</i>	20		
<i>Using your answering machine from the cordless handset</i>	20		
<i>Security code</i>	23		
<i>Call screening</i>	23		
<i>Memos</i>	24		
<i>Remote access</i>	25		
<i>Control your answering machine from another phone using a TouchTone™ keypad</i>	25		
<i>Operating the answering machine</i>	26		

Introduction

Your Freestyle 1025 is designed for ease of use and made to the high standards set by BT

Thank you for making the right choice. You can expect your Freestyle 1025 to provide many years of quality service. Please read the instructions carefully before use and keep this user guide for future reference.

For your records

Date of purchase:
Place of purchase:
Serial number: (on the underside of the base unit)
Purchase price:

For warranty purposes, proof of purchase is required, so please keep your receipt.

Emergency calls

The emergency services can be contacted in the UK by dialling **999** or **112**.

As the Freestyle 1025 is a mains-powered cordless telephone, in certain situations you may not be able to make an emergency call:

- If there is severe radio interference.
- If the handset batteries fail.
- If there is a power cut.

Unpacking your Freestyle 1025

Check that your Freestyle 1025 is complete. When you unpack you should have:

- Freestyle 1025 handset including rechargeable battery

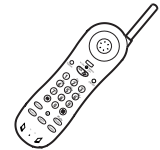

- Freestyle 1025 base unit with answering machine



- Mains power lead with attached 13 amp adaptor plug

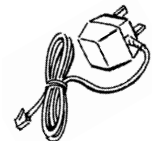

- Wall-mounting bracket, 2 screws and wall plugs for wall mounting

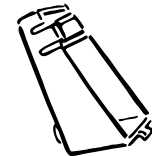

Customer Helpline

*If you have problems with your phone, call the Freestyle 1025 Helpline Service on **0845 769 7146**.*

Setting up

Follow these steps to get your Freestyle 1025 ready for use

1 Handset aerial

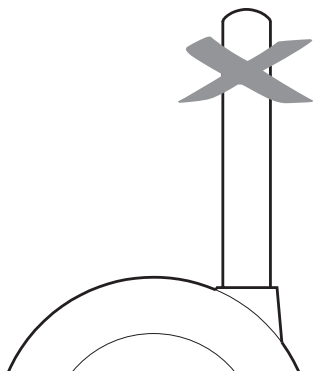

Your Freestyle 1025 uses a compact aerial which does not pull out.

2 Check your telephone socket

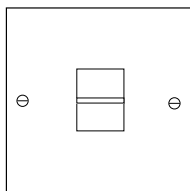

If you do not have a modern-style telephone socket, call **Freefone 0800 800 150** and ask for a BT engineer to come and fit the correct socket.

This is a chargeable service.

3 Plug the mains adaptor cord into the back of the base unit

To prevent the cable being pulled out by accident, route it through the channel on the underside of the base.

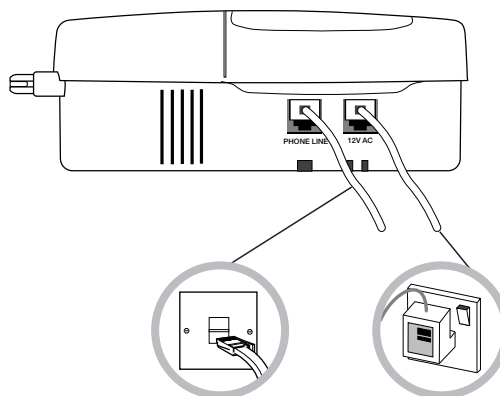

Electrical storm warning

During periods of electrical storm, you are advised to disconnect your apparatus because damage may occur.

If a fault occurs during the 12-month warranty period and it is due to accidental or wilful damage (including lightning and electrical damage), BT will not replace or repair free of charge.

4 Plug the 3 pin adaptor into the mains power socket and switch on

Your Freestyle 1025 begins the set-up procedure which takes a few seconds.

- The message counter flashes.
- The pre-set outgoing message is ready to use.
- The answer delay is set to 6 rings.
- The answering machine is switched to ON.
- The loudspeaker volume is set to level 5 (from a range of 0-H).
- The machine announces the answer delay setting: "Calls will be answered after 6 rings".

Mains power adaptor

The Freestyle 1025 must only be used with the adaptor supplied.

Using any other adaptor will invalidate the approval given to this apparatus.

5 Charge the handset battery for at least 24 hours

When you first use your Freestyle 1025, the rechargeable batteries in the handset need charging for 24 hours.

Place the handset on the base unit face down, ensuring the contacts are touching.

The **CHARGING** light on the base unit comes ON.

After the handset has been charged for 24 hours, your phone is ready for use.

As a rule, placing the handset on the base unit overnight will keep the batteries fully charged for all normal use.

The **CHARGING** light remains on until the handset is removed from the base unit.

When fully charged and in good condition, the handset batteries will provide up to 7 hours continuous talk time or 72 hours standby.

*If the batteries are running low, the **BATT LOW** light will flash.*

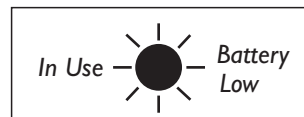

If you are making a call and the batteries are running low, the handset will beep every 10-15 seconds and you have about 2 minutes before the call is cut off.

Place the handset on the base unit to recharge.

Battery Care

Batteries cannot be overcharged. However, leaving the handset on the base unit all the time can deteriorate rechargeable batteries. To get the longest possible life from your batteries, take the handset off the base for a few hours each day.

6 Plug your Freestyle 1025 into the phone socket

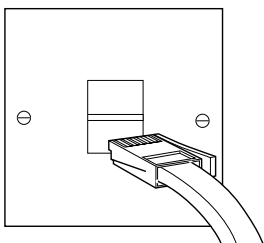

7 Fully extend the telescopic aerial on the base unit



For the best reception

Try to avoid putting the telescopic aerial near other electrical appliances, fluorescent lights and large metallic objects such as cookers, radiators and garage doors as these may cause interference and reduce the quality of your calls.

8 To plan the location of the base unit

Your Freestyle 1025 works by sending and receiving radio signals between the base unit and the handset.

The strength of the signal depends on where you site the base unit and how the aerial is deployed.

The higher the base unit is located, the better. An upstairs room is ideal. The following points should be considered:

- It should be within easy reach of a mains socket and a telephone socket. A new-style telephone socket is needed for this product. If you do not have one, call us on **Freefone 0800 800 150**.
- Try to avoid locations near metallic obstructions or electrical appliances, such as TV sets, fridges, computers, fluorescent lights, radiators, metal pipes and metal window frames.
- The Freestyle 1025 can be wall-mounted by using the bracket and screws supplied; see pages 38-39.

Your Freestyle 1025 is now ready for use

Using your Freestyle 1025 telephone

Making and receiving calls

The handset range is up to 200 metres from the base unit in ideal conditions. If you start to go out of range while using the phone, you will hear warning beeps. If you do not come back in range, your call will be cut off.

To make a call

Press buttons in order shown

Lift the handset off the base.



Press the **TALK** button. The handset **IN USE** light comes on. The base unit light comes on. Listen for dial tone.

Dial the number.

To end a call



Press the **TALK** button.

Or



Replace the handset on the base.

To receive a call

When the phone rings:



If your handset is on the base unit, simply pick it up to answer the call.

Or

If your handset is off the base, press the **TALK** button to answer the call.



To redial the last number

You can redial a number of up to 32 digits long.



Press the **TALK** button. You hear the dialling tone.



Press the **REDIAL** button. The last number you called is redialled.

To ensure the best sound quality

Your Freestyle 1025 automatically scans available radio channels between the handset and base for the best quality signal. However, if you hear noise or interference during your call:



Press the **CHANNEL** button. Your Freestyle 1025 will select a new channel for you.

If you go out of range

Your Freestyle 1025 has a range of 200 metres in ideal conditions.

However, if you go out of range during a call, you will hear a series of beeps. Move closer to the base to re-establish the signal.

Using the Secrecy button

You can prevent your caller from hearing you while you talk to someone else close by.



Press and release the **SECURITY** button. The **IN USE** light flashes and you will hear an audible tone every 8 seconds.

To return to your caller, press and release the **SECURITY** button.

Using the Quickdial to store and dial numbers

Your Freestyle 1025 handset can store up to 10 separate phone numbers, each up to 20 digits long. You can then dial each number by pressing just 2 buttons.

To store a number in the memory



Press the **QUICKDIAL** button. You hear a beep and the handset **IN USE** light will flash.



Press one of the **0-9** buttons to set the location code under which your phone number will be stored.



Dial the number you want to store.



Press the **QUICKDIAL** button. You hear a confirmation beep. The number is stored.



Repeat these steps for any other numbers you want to store, using a different **0-9** location code for each one.

Storing a number in the memory automatically overwrites any previous number stored under the same location code.

Stored numbers can include those for switchboard and network services that use the **★** and **#** buttons as well as the **PAUSE** and **RECALL** functions.

To dial a stored number

Press buttons in order shown



Press the **TALK** button.



Press the **QUICKDIAL** button.



Press the **0-9** location code under which the number you want is stored. The number is dialed automatically.

On the back of your handset is a label for you to record the names of the contacts stored under the quickdial memory buttons.

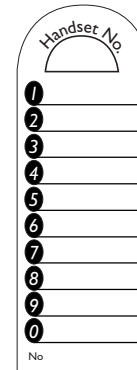

To store an engaged number in the memory

If you ring a number that was engaged you can put it in the Quickdial memory.



Press **QUICKDIAL** you hear a beep.



Store memory location **0-9**.



Press **REDIAL**.



Press **QUICKDIAL**.

The number is now stored in the memory.

To store a number of more than 20 digits



Press the **QUICKDIAL** button.



Press one of the **0-9** buttons to set the location code under which your phone number will be stored.

DIAL

Dial the first 20 digits.



Press the **QUICKDIAL** button. You hear a confirmation beep. The number is stored.



Press the **QUICKDIAL** button again.



Press a different **0-9** button to select a second location code under which to store the remaining digits.

DIAL

Dial the remaining digits.



Press the **QUICKDIAL** button. You hear a confirmation beep. The rest of the number is stored.

Did you know?

*You can mix manual and memory dialling as required. For example, you can dial the area code **0181 380** from the memory and then complete the number manually.*

To dial a stored number of more than 20 digits



Press the **TALK** button.



Press the **QUICKDIAL** button, then the first **0-9** location code number. The number begins dialling automatically.

0-9



When the first part of the number has been dialled, press the **QUICKDIAL** button again, then the second **0-9** location code number. The rest of the number is dialled.

0-9

To adjust the incoming speech volume

During a conversation you can adjust the volume of the incoming caller.



Volume

Press the **VOLUME** button to increase or decrease the speech volume.

To adjust the handset ringer volume

When the handset is not in use you can adjust the ringer volume.



Volume

Press the **VOLUME** button to increase or decrease the handset ringer volume. The Freestyle 1025 has 3 settings: High, Low and Off.

To set the volume to Off, press and hold the **VOLUME** button until you hear a confirmation beep.

To adjust the handset ringer melody



Press and release the **QUICKDIAL** button.



Volume

Press and release the **VOLUME** button.

1-3

Press either the **1**, **2** or **3** button to select the melody required – you will hear the melody selected when pressed.



Press the **QUICKDIAL** button to confirm the setting. You will hear a confirmation beep.

NOTE

*The **VOLUME** button must be pressed within 3 seconds or the Freestyle 1025 will return to standby.*

To adjust the base station ringer volume

Your Freestyle 1025 has a volume range of **0-H** (**0** = Off, **H** = High).

Stop

Press the **STOP** button for 1 second.

You hear a confirmation beep. Display shows current level.

Volume +

Press **VOL +** to increase the volume.

Volume -

Press **VOL -** to decrease the volume.

As you press, a beep sounds at the level you are selecting.

Call return (1471)

This service lets you easily find who called your number last.

To use the 1471 feature



Press the **TALK** button and wait for a dialling tone.

1471

Press the **1471** button. You hear the number of your last caller announced and the time they called. If a call is made and the caller withholds their number, the time of the call is still stored but not the number.



Press the **TALK** button again – or replace the handset on the base – to return to standby.

NOTE

To withhold your own number.

*Dial 141 before you dial the number you want.
You will need to do this even if you are ex-directory.*

Call Waiting

NOTE

Call Waiting service requires set-up by BT or your service provider and connection to a digital exchange.

If an incoming call arrives while you are already engaged on a telephone call, you will hear a soft beep every 5 seconds (this beep is not audible to the person you are speaking to).

Instead of the engaged tone, the second caller will hear an announcement to hold on as you are aware that there is a second call.

To use Call Waiting

You can answer the second call, without disconnecting your first caller, by pressing the **R** button. The first caller will be put on hold.

R

When you have spoken to the second caller you can return to the first caller by pressing the **R** button again. You can switch back and forth between the 2 calls without disconnecting either if you wish.

R

If you wish to disconnect the first call, press the **TALK** button after speaking to the first caller.



The handset will then ring. Press the **TALK** button again and continue with the second caller.



The second caller will only be charged for their call from the moment you answer and not while they are waiting for your initial contact.

To switch from pulse to tone dialling

If you are connected to a pulse dialling exchange, you can still use services such as phone banking that require tone dialling.

KEYPAD



Call the telephone number you require in pulse mode as usual.

When you have been connected, press the ★ button on the keypad to set your telephone to tone dialling for the duration of the call.

When you hang up, your Freestyle 1025 will automatically switch back to pulse dialling.

To insert a pause

With some switchboards, after dialling the access code you may have to wait for a moment while the switchboard picks up an outside line. If so, press the **REDIAL** button to insert a 2.5 second pause before keying in the telephone number.



To use the recall button



This button signals either time break recall or earth recall depending on the setting of the dialling mode. If you are connected to a PBX (Private Branch Exchange), contact your PBX supplier for further information.

To page the handset

If you misplace the handset, you can use **PAGE** to find it again.



Press the **PAGE** button on the base. The handset will beep. The **IN USE** light on the base flashes.



Stop the handset beeping by pressing the **PAGE** button again

or



the **TALK** button on the handset. (Please note: pressing the **TALK** button will cut off the line, you will then need to put the handset back onto the base unit.)

To set the dialling mode



Press the **QUICKDIAL** button during standby mode.



Press the ★ button.



Press **1** for Tone dialling.



Press **2** for Pulse dialling.



Press the **QUICKDIAL** button to finish the setting (you will hear a confirmation tone). If no instruction is received during this process within 8 seconds, there will be a beep and the process will be cancelled before returning to standby mode.

Using the Freestyle 1025 answering machine

About your Freestyle 1025 answering machine

Your Freestyle 1025 can digitally record up to 14 minutes of messages, with each incoming message lasting a maximum of 3 minutes.

Your Freestyle 1025 answering machine can operate from the base unit and also directly from your handset. When you set up your answering machine, some of the features, such as recording your outgoing message, must be set up via the handset.

The outgoing message is the message a caller first hears when the answer machine picks up their call. The Freestyle 1025 has a pre-recorded outgoing message which is *“Hello, your call cannot be taken at the moment, so please leave your message after the tone”*. If you wish, you can record your own outgoing message to replace the pre-recorded message (see page 15).

Message display on the base station



The message display on your base station lets you know the status of your Freestyle 1025 answering machine.

Display	Definition
(Blank)	Power off.
-	Power on – answer off mode.
0-9	Answer-on mode, 0-59 messages.
P (flashing)	Message paused.
r (flashing)	Message recording (memo, outgoing message or incoming message).
A (flashing)	Remote access in progress.
F (flashing)	Memory full.
t or 2 to 9	Setting or reading answer delay.
E (flashing)	Error.
8-0	Counting down.
C-0 (flashing)	Day/Time needs to be set.

Setting up your answer machine

To switch the answering machine on/off

Answer
on off

Press the Answer on/off button.

If you hear *'Answer off'* the answering machine is switched off. Display flashes between a dash and the number of messages saved in the memory, or display shows a single dash if there are no messages.

Press again to hear *"Answer on"*. Your Freestyle 1025 will now answer an incoming call and record any messages. Display shows the number of messages held in the recording memory.

To record your outgoing message via the handset

The Freestyle 1025 has a pre-recorded outgoing message which is *"Hello, your call cannot be taken at the moment, so please leave your message after the tone"*.

You can record your own outgoing message to replace the pre-recorded message. If you record your own message, the pre-recorded message is automatically removed and stored in the memory, in case you wish to reinstate it.

Your Freestyle 1025 has a recording capacity of 14 minutes. Any outgoing message you record can be up to 30 seconds long.

Pick up the handset.

Press the **SCREEN/MENU** button.

Press the **9** button. The machine announces: *"Please speak after the tone, to end recording press #"*.

Once the **#** button has been pressed, your outgoing message will be played back.

Menu
Screen

9

To check your outgoing message

You can play back your outgoing message at any time.

Pick up the handset.

Press the **SCREEN/MENU** button.

Press the **8** button. Your outgoing message is played back.

Menu
Screen

8

To delete your outgoing message

You can delete your outgoing message and return to your Freestyle 1025's pre-recorded outgoing message.

Menu
Screen

Press the **SCREEN/MENU** button.

8

Press the **8** button.

"Your outgoing message is..."

Delete
JK
5

While the message is playing, press the **5** button.

Your Freestyle 1025 will beep and play its pre-recorded outgoing message.

"Hello, your call cannot be taken at the moment, so please leave your message after the tone."

Your own message has now been replaced by the Freestyle 1025's original pre-recorded message.

You can stop any function at any time and return to the last 'Answer On' or 'Answer Off' setting by pressing the **STOP** button on the base unit.

Stop

NOTE

Press the **SCREEN/MENU** button at any time to return to Standby mode.

To set the day and time

NOTE

You only have 8 seconds to set up your Day and Time otherwise the Freestyle 1025 will return to the standby mode.

Your Freestyle 1025 automatically adds the day and time to all messages and memos.

When you switch on your Freestyle 1025 for the first time, the clock is set to Saturday 12:01. You can change the day and time as required. The display will show \square until the clock has been set.

To set the day and time for each incoming message left on the Freestyle 1025 answer machine:

Press the **SCREEN/MENU** button.

Press the ***** button. The machine announces *"To set day and time press *"*.

To hear the day and time, press **#**.

Press the ***** button. The machine announces *"Please enter new day and time after the tone"*.

KEYPAD

Enter the day, followed by time (using the 24 hour clock).

1 = Sun, **2** = Mon, **3** = Tues, **4** = Wed,
5 = Thur, **6** = Fri, **7** = Sat.

For example:

1 1415 = Sunday 2.15pm

or

5 0915 = Thursday 9.15am

Menu
Screen

*

*

To adjust the loudspeaker volume

Your Freestyle 1025 has a volume range of 0-H. The pre-set level is 5.

Volume +

Press **VOL +** to increase the volume. When you reach the maximum volume, the LED display shows H.

- Volume

Press **VOL -** to decrease the volume. When you reach the minimum volume, the LED display shows 0.

If you adjust the volume when the answering machine is not being used, a beep sounds at the level you are selecting. When the volume is at its highest or lowest setting, you hear 2 beeps.

Incoming messages

Your Freestyle 1025 will automatically record an incoming message when it is connected to your phone socket and is set to 'Answer on'.

While a message is being recorded, the display flashes r. It will stop recording if the caller stops speaking for longer than 7 seconds.

When a message has been received, the LED display counts up by one.

Your Freestyle 1025 automatically adds the day and time of recording to the end of each message.

3 minutes is the maximum time allowed for each incoming message. If the maximum message length is reached – or if the memory becomes full – the caller hears the message *“Thank you for calling”* and your Freestyle 1025 hangs up.

Your Freestyle 1025 will also hang up if you press the **STOP** button.

If there is less than 40 seconds of recording memory left, the caller will hear the announcement *“Please complete your call within 10 seconds”* after the outgoing message is played.

Your Freestyle 1025 can hold a maximum of 59 incoming messages or up to a total of 14 minutes of recording.

When more than 9 messages are stored on the answering machine the LED display shows 9 flashing.

When the recording memory is full, the display alternates between the number of messages and F.

If the answering machine is switched on, and the memory is full, incoming callers will hear the pre-set message *“Hello, your call cannot be taken at the moment and you cannot leave a message, so please call later”*. If the caller is still on the line after 8 seconds, they hear the message *“Thank you for calling”* and your Freestyle 1025 hangs up.

NOTE

If a call comes in while you are playing back a message or memo, the playback stops and the machine is ready to take the call.

Using your answering machine from the base station

To play back a message at the base

You can play back your messages at the answering machine:



Press the **PLAY** button.

You hear the announcement “*You have (n) messages*” and your messages are played back, starting with the first message received.

At the start of each message, the number of the message is announced. At the end, you hear the day and time of recording.

*Press the **STOP** button at any time during playback to stop messages playing.*

To pause a message at the base



While listening to the message, press the **PLAY** button. Your Freestyle 1025 will beep every 10 seconds during pause.

Display shows F.



Press the **PLAY** button again to resume playback.

If playback is not resumed within 60 seconds, the machine automatically resets to ‘Answer on/off’ mode.

To skip forward and backward through messages at the base

During playback:



Press the **SKIP** button and the next message is played. If you press and hold this button the current message will be played back at 1½ times the speed.



Press once to return to the start of the current message. Press twice to return to the start of the previous message.

To delete an individual message at the base

During playback:



Press the **DELETE** button.

To delete the message being played. You hear the announcement “*Message deleted*”.

The message is not deleted yet, but at the end of playback when there is an 8-second countdown. Let the countdown reach 8 and all the selected messages are deleted and the remaining messages are saved.

To delete all messages at the base

When all messages have been played back you hear the announcement “*End of messages*” and the LED display counts down from 8-0.



During the 8-0 countdown press **DELETE**. At the end of the countdown you hear the confirmation announcement “*All messages deleted*”.

To cancel deletion from the base

Stop

Cancel deletion by pressing the **STOP** button during the 8-0 countdown. All messages will be saved including any marked for deletion.

Answer delay

Answer delay sets the number of times your Freestyle 1025 will ring before answering a call. The original setting is for your machine to answer after 6 rings. You can change this setting between 2-9 rings or Time Saver.

NOTE

If you set your 1025 Answer Delay to Time Saver this means that when you call in from another phone (remote access), if any messages have been recorded your Freestyle 1025 will answer after only 2 rings. If there are no messages, it will answer after 6 rings, thereby allowing you the option of hanging up before your Freestyle 1025 answers. In using Time Saver, you can avoid the cost of a call.

To check the answer delay setting at the base station

Press buttons in order shown

Skip ▶

Press the **SKIP >** button. Your Freestyle 1025 will announce the current setting. “*Calls will be answered after 6 rings*”.

To change the answer delay setting

Skip ▶

Press and hold the **SKIP >** button until the current setting is announced “6”. Keep holding the **SKIP >** button and your Freestyle 1025 will announce the answer delay options: 7, 8, 9 “*Time Saver, 2, 3, 4, 5*”.

Skip ▶

When you hear the setting you want, release the **SKIP >** button. Your Freestyle 1025 will then announce the new setting e.g. “*Answer delay, Time saver*” and return to ‘Answer on/off’ mode.

Message alert

When new messages have been received, your Freestyle 1025 will beep every 10 seconds. The volume of the beep is at the volume you have set for the loudspeaker.

To switch the message alert on or off

When the answering machine is in its idle state:



Press the **SKIP** button to confirm the current setting.

Press and hold to change the setting.

The machine announces, "*Message alert off/on*" as appropriate.

Using your answering machine from the cordless handset

You can use your Freestyle 1025 for a variety of functions: to listen to your messages; delete, skip forward or backward; and record a memo or new outgoing message. You can also use it to screen an incoming call.



To use the Freestyle 1025 answer machine from the handset, use the table below which shows which buttons to press for each function.

Press the **SCREEN/MENU** button  then:

The voice prompt will guide you through each function.

Press

1	To hear main menu.
2	To play all messages.
3	To play new messages.
4	Skip back during messages.
5	To delete during messages.
6	To skip forward during messages.
7	To record a new memo.
8	To play the outgoing message.
9	To record a new outgoing message.
0	To set a new security code.
★	To set Day and Time.

NOTE

*To return the handset to standby at any time, press the **SCREEN/MENU** button.*

To play your messages from the handset

When the Freestyle 1025 is in Standby mode:

Press the **SCREEN/MENU** button to access the menu facility.

Press the **2** button.

The message will then be played back followed by the day and time of the call.

If you have 2 or more messages, they are played back in the order in which they were received.

When all your messages have been played back, your Freestyle 1025 announces: *“End of messages”*.

To hear main menu, press **1**.

To delete all messages, press **5**. Your Freestyle 1025 will return to standby mode after 8 seconds.

Menu
Screen

Play
ABC
2

1

Delete
JKL
5

To skip forward or backward through messages at the handset

When playing back messages, you can skip forward to the next message or backward to the start of the current or previous message.

Menu
Screen

Press the **SCREEN/MENU** button to hear main menu.

Play
A B C
2

Press the **2** button, while the messages are being played back.

Skip
M A O
6

Press the **6** button to start playing the next message.

If you skip beyond the last message, your Freestyle announces *“End of messages”*.

Skip
G V
4

Press the **4** button once to replay the current message.

Skip
G V
4

Press the **4** button twice to go to the start of the previous message.

To delete individual messages at the handset

Menu
Screen

Press the **SCREEN/MENU** button.

Play
A B C
2

Press the **2** button.

Delete
JK
5

When the message you wish to delete is playing, press the **5** button.

Skip through your messages to make any further deletions.

To delete all messages at the handset

1

Press the **1** button to hear main menu.

Play
A B C
2

Press the **2** button to hear your message.

Following playback of messages, your Freestyle 1025 will announce: *“End of messages”*.

Delete
JK
5

Press the **5** button to delete all messages.

Your Freestyle 1025 will announce: *“All messages deleted”*.

After 8 seconds your Freestyle 1025 will return to ‘Answer On/Off’ mode.

Security code

Your Freestyle 1025 has a security PIN code which must be entered when remotely accessing the answering machine. This ensures your messages are private and can be accessed only by the users who know the security code. Your Freestyle 1025 answering machine has a preset security code of **000**.

To set the security PIN code

A new security code can only be set via the handset.

Menu
Screen

Press the **SCREEN/MENU** button.

0

Press the **0** button.

*

To set a new security PIN code press *****.

#

Press the **#** button to hear security code.

Enter a 3-digit code after you hear the beep. Your Freestyle 1025 announces the new security PIN code.

Menu
Screen

Press the **SCREEN/MENU** button to return your Freestyle 1025 to standby.

Or

The Freestyle 1025 will return to standby automatically after 8 seconds.

Call screening

You can let your answer machine pick up a call, even if you are in. This allows you to identify the caller and decide whether to take the call.

Make sure that the volume is set to an audible level (see page 17).

Allow the incoming call to be answered by your Freestyle 1025 as normal. You will hear the caller begin to leave a message.

To screen a call from the base unit

Press buttons in order shown



If the handset is resting on the base unit and you decide to take the call, lift the handset and speak to the caller.

Recording will stop automatically.

To screen a call via the handset

When your Freestyle 1025 starts to record an incoming message, the **IN USE** light flashes.

Menu
Screen

Press the **SCREEN/MENU** button. You can hear the caller on the handset.

Or

Talk 

To interrupt recording and talk to your caller, press the **TALK** button.

Memos

A personal memo can be recorded on your Freestyle 1025 and left as a message for another user. Memos can be of any length, up to the maximum recording capacity (3 minutes), but you should keep them short to allow time for recording incoming messages. Memos can only be recorded by using the handset.

NOTE

To play or record your outgoing message, please refer to page 15.

To record a memo

Menu
Screen

Press the **SCREEN/MENU** button.

PC
7

Press the **7** button. The Freestyle 1025 announces: *"Please speak after the tone"*.

Your Freestyle 1025 display shows: 'r'

#

Press the **#** button to end recording.

When you have completed your memo, your Freestyle 1025 announces:
"To hear main menu, press 1".

Your memo is now stored and can be played back later. Memos are stored in the same way as incoming messages, and the message counter on the base unit will increase by 1.

NOTE

To play back, delete or skip forward or backward through memos, follow the instructions for playing back messages (pages 21 to 22).

Remote access

Control your answering machine from another phone using a TouchTone™ keypad

You can turn your Freestyle 1025 answering machine on and off and listen to your messages from any TouchTone™ telephone. To protect your privacy, messages can only be accessed by entering a 3-digit security code.

The code is pre-set to **000** and can be changed.

To change your security PIN code, please refer to page 23.

To check for messages

Dial your phone number and wait.



When you hear your outgoing message, press the ★ button on your phone. You will hear *“Please enter your security code”*.

CODE

Key in all 3 digits of your security code.

Once you have correctly entered your security code, if you have no messages you will hear *“You have no messages, to hear main menu press 1.”*

You now have 8 seconds to enter any other instructions before your Freestyle 1025 hangs up.

If you have messages you will hear *“You have X new messages”*.

Your Freestyle 1025 will then play your messages.

NOTE

If you enter your security PIN code incorrectly, after the second attempt, your Freestyle 1025 will announce: “Thank you for calling” and will then hang up.

Operating the answering machine

When you have accessed your answering machine, you can operate using the keypad numbers on the phone you are using.

The main menu

The main menu lets you operate a range of answering machine functions. Simply follow the instructions as announced:

“To play all messages, press 2”

“To play new messages, press 3”

“To skip back during messages, press 4”

“To delete during messages, press 5”

“To skip forward during messages, press 6”

“To play outgoing message, press 8”

“To record a new outgoing message, press 9”

“To set answer on or off, press 0”

“To hear main menu, press 1”

Freestyle 90/130/1025/1200 Additional Handsets

You can buy and use up to 3 Freestyle additional handsets with your Freestyle 1025 to extend your phone system, without needing to install extension sockets for each new phone.

Each additional handset is supplied with its own charger and user instructions, but the following information will tell you how to register and use an additional handset with your Freestyle 1025.

Registering your handset

You must register your Freestyle additional handset before it can be used with your Freestyle base unit. Make sure that each additional handset is registered with a different number (2, 3 or 4) so it can be identified from other additional handsets. *See page 28.*

NOTE

The following erasing and re-registering procedure can be used for either re-registering an original handset or registering an additional handset. If you wish to re-register please follow the instruction adjacent, using your original handset where it refers to additional handset.

To erase a registration code

Quickdial

Press and release the **QUICKDIAL** button.



Channel

Press and release the **CHANNEL** button.



Press the **★** button four times.

Quickdial

Press and release the **QUICKDIAL** button.

You will hear a confirmation beep, the old registration code is now erased and you can re-register your additional handset following the procedure below.

To register an additional handset

Place the handset you wish to register on the base unit and then remove it.

Page

Press and hold the base unit **PAGE** button for 5 seconds.

As soon as the **IN USE** light begins to flash, release the **PAGE** button and place the additional handset on the base unit.

Your additional handset is registered automatically and you will hear a long confirmation beep and the **IN USE** light will stop flashing.

NOTE

*Your additional handset must be placed on the base unit within 5 seconds of the **IN USE** light flashing.*

To re-register an additional handset

Before re-registering, the old registration code must first be erased. If necessary you can re-register your additional handset by simply following the above procedures.

NOTE

*Check that your additional handset is registered correctly by pressing the **TALK** button and listening for a dial tone. If you do not hear a dial tone your additional handset is either out of range of the base unit or it has not been registered properly, or the base unit line cord is not plugged in.*

To set the handset number

Each additional handset must be assigned an identity number (2, 3 or 4). Your Freestyle 1025 handset is already numbered as HANDSET1. Additional handsets can then be numbered as they are added.

NOTE

Your Freestyle additional handset is pre-set to handset number 2.

To set a handset identity number

Quickdial

Press the **QUICKDIAL** button.

Secrecy

Press the **SECRECY** button.

KEYPAD

Enter the identification number (2-4) using the keypad.

Quickdial

When you have entered the number, press the **QUICKDIAL** button.

You will hear a beep confirming that the new number has been stored.

NOTE

Make a note of the identification number by writing it on the handset's directory label.

Basic use of Freestyle additional handsets

NOTE

Like all cordless phones, the Freestyle additional handset must be charged for 24 hours before initial use.

Basic operation of additional handsets is the same as that of your Freestyle 1025 handset.

NOTE

You cannot control the answering machine from the 90/130/1025/1200 additional handset, and it does not have the call screening facility.

The handset range is up to 200 metres from the base unit in ideal conditions. If you start to go out of range while using the phone, you will hear warning beeps. If you do not come back in range, your call will be disconnected.

To make a call

Lift the handset off the charger.



Press the **TALK** button. The **IN USE** light comes on and the handset buttons illuminate.

Listen for the dialling tone.

KEYPAD

Dial the number you want.

NOTE

*If you do not hear a dialling tone after pressing the **TALK** button, wait a few seconds. On a few exchanges, there may be a delay.*

To end a call



Press the **TALK** button or replace the handset.

Transferring calls between handsets

While on a call (ie. in talk mode):



Press the **SECRECY** button.

Enter the number of the handset you want to transfer the call to. The specified handset will ring.



To answer the call, press the **TALK** button.

NOTE

*If the call is not answered, it is returned to the original handset after 30 seconds. The original handset will ring to let you know if this has happened. To avoid having to wait 30 seconds for the call to be returned, you can press the **TALK** button to cancel the transfer of the call.*

Help

If you have any problems using your Freestyle 1025, this section will give you the most common, easy-to-follow solutions.

<i>Telephone problems</i>	<i>Possible cause</i>	<i>Solution</i>
<ul style="list-style-type: none">• No dialling tone.• Telephone will not dial out.• Telephone cannot receive calls.• Beeps six times and drops calls.	<p>Telephone not connected to telephone line.</p> <p>Mains disconnected.</p> <p>Power cut.</p> <p>Handset battery pack is discharged.</p> <p>Handset is not registered to base unit.</p>	<p>Replace handset on base unit for 10 seconds and try again. If this does not work, disconnect the handset battery from the handset for 10 minutes. Also disconnect the mains power.</p> <p>Then reconnect the base unit to the mains, then replace the handset on the base unit for 10 seconds and try again.</p> <p>Plug the telephone into the telephone line.</p> <p>Wait until the power is restored.</p> <p>Place the handset on the base unit and recharge it for 24 hours, ensuring the charging light is on.</p> <p>Re-register the handset. Refer to page 27 to first erase registration and then re-register the handset.</p>
<ul style="list-style-type: none">• You have dialling tone but the telephone will not dial out.	<p>You may be trying to use tone dialling on a pulse dialling exchange.</p> <p>You are connected to a PBX and are not dialling the access code.</p>	<p>Set the mode to P-E (pulse dialling).</p> <p>Use the PBX access code.</p>
<ul style="list-style-type: none">• Handset does not ring.• No IN USE light on handset.	<p>Handset battery pack is discharged.</p>	<p>Place the handset on the base unit and recharge it for 24 hours.</p>

Telephone problems	Possible cause	Solution
<ul style="list-style-type: none"> • Handset does not ring, but IN USE light show on handset. 	<p>The handset ringer may be set to its minimum setting.</p>	<p>Increase the handset ringer volume.</p>
<ul style="list-style-type: none"> • Base unit does not ring but lights show on base unit. 	<p>Telephone is not connected to the telephone line.</p> <p>The base ringer is set to off.</p> <p>Line fault or faulty socket.</p>	<p>Plug the telephone into the telephone socket.</p> <p>Set the base ringer settings to a higher volume.</p> <p>Try the telephone on another socket or another line. If the telephone works, contact BT or your telephone network operator for repairs to the line or socket.</p>
<ul style="list-style-type: none"> • Base unit rings too loudly / softly. 	<p>Base unit setting is too High or Low.</p>	<p>Set the ringer setting accordingly.</p>
<ul style="list-style-type: none"> • Neither base or handset ring, but lights show on base and handset. 	<p>The ringer volumes on both the handset and base unit could be set to minimum.</p> <p>Check the REN (see page 34). If you connect too many telephones or devices to your line, they may not all operate correctly.</p> <p>If your telephone is connected to an extension socket, it may have been connected incorrectly.</p>	<p>Increase the ringer volume on the base unit and handset.</p> <p>If the REN exceeds 4, disconnect one or more telephones or devices.</p> <p>Check with your telephone engineer that the extension socket has been installed correctly.</p>
<ul style="list-style-type: none"> • Callers are faint. • Interference. • Buzzing. • Whooshing. • Echoing. • Tinniness. 	<p>The base unit telescopic aerial is not extended as high as possible.</p> <p>You are moving out of range.</p> <p>Radio channel interference.</p> <p>Radio channel interference.</p> <p>The base unit or the handset are too close to electrical equipment or metal obstructions.</p>	<p>Extend the base unit telescopic aerial as far as possible.</p> <p>Move closer to the base unit.</p> <p>Press the CHANNEL button on the handset, to select a clearer channel.</p> <p>Press the CHANNEL button on the handset, to select a clearer channel.</p> <p>Relocate the base unit or move around with the handset until reception improves.</p>

Telephone problems	Possible cause	Solution
<ul style="list-style-type: none"> • No Quickdial store. 	<p>You may be trying to store the number with the IN USE light on.</p>	<p>Ensure that the IN USE light is off before storing the number.</p>
<ul style="list-style-type: none"> • No number stored on 1471. 	<p>Stored number may have inadvertently been overwritten.</p>	<p>Press the QUICKDIAL button, press the relevant Select Services button, then press the QUICKDIAL button again. This will reset the button.</p>
<ul style="list-style-type: none"> • Call appears to have been cut off after pressing the SECRECY button. 	<p>You may have pressed a number key on the handset after pressing the SECRECY button. The current handset will try to transfer the call to another handset.</p>	<p>Wait 30 seconds; the call will return to the current handset. Or press the TALK button and the call will return immediately.</p>
<ul style="list-style-type: none"> • BATT LOW light on the handset is flashing. 	<p>The handset needs recharging.</p>	<p>Replace the handset on the base unit, ensuring that the base unit is plugged in and that the CHARGING light is on.</p>
<ul style="list-style-type: none"> • No CHARGING light on the base unit. 	<p>Dirty contacts on base unit or handset.</p>	<p>Clean the contacts with a dry cloth. Heavy soiling can be removed with a pencil eraser.</p>

Answering Machine problems	Possible cause	Solution
<ul style="list-style-type: none"> • General problems. 	None of the answering machine functions will operate while the telephone is in use.	Ensure that the telephone is not in use before operating the answering machine.
<ul style="list-style-type: none"> • Will not record incoming messages. • Will not answer calls. 	<p>The answering machine is switched off.</p> <p>The answering machine is full.</p>	<p>Switch the answering machine on manually or by remote control.</p> <p>Delete some or all of your messages manually or by remote control, to make room for new messages.</p>
<ul style="list-style-type: none"> • No call screening from the base unit. • Cannot hear messages when played. 	The volume is set too low.	Press and release the end of the volume control with the larger symbol until the unit is loud enough.
<ul style="list-style-type: none"> • When accessing your machine remotely, your security PIN code does not work. 	Incorrect security PIN code entered.	Re-set your security PIN code. <i>See page 23.</i>

Technical information

Approval for use

Your Freestyle 1025 is tested and approved for connection to public networks, provided it is used in accordance with the guidelines in this user guide.

You may connect it:

- To direct exchange lines.
- To extensions with new plug and socket arrangements provided with these direct exchange lines.
- To compatible switchboards.

You may NOT connect it:

- To shared service (party) lines.
- As an extension to a payphone.

This phone is designed for UK use only. Using it abroad may violate local radio laws.

The base unit is intended for use when powered from the 9V AC mains adaptor supplied, which conforms to EN60950. Any other usage will invalidate the approval given to this apparatus if, as a result, it ceases to comply with EN60950.

Environment

Your Freestyle 1025 should be kept free of dust, moisture, high temperature and vibration, and should not be exposed to direct sunlight. Do not stand it on carpets or other surfaces which generate fibres, or place it in locations which prevent the free flow of air over its surfaces.

WARNING

The apparatus is only designed to be operated in a normal office or domestic environment where the relative humidity does not exceed 60%. It should not be used in bathrooms or near water.

How many phones can you have?

All items of telephone equipment have a Ringer Equivalence Number (REN), which is used to calculate the number of items which may be connected to any one telephone line. Your Freestyle 1025 has a REN of 1. A total REN of 4 is allowed. If the total REN of 4 is exceeded, the telephones may not ring. With different telephone types there is no guarantee of ringing, even when the REN is less than 4.

Connecting to a switchboard

Your Freestyle 1025 may be connected to compatible switchboards. If in doubt, your switchboard supplier or maintainer should be able to offer help. Advice on connection to BT switching systems can be obtained by dialling BT on **152**.

If you do not have a compatible switchboard, it cannot be guaranteed that your Freestyle 1025 will operate correctly under all possible conditions of connection.

Call security

Your Freestyle 1025 has its own digital security code that prevents other cordless phone owners from using your phone line. This ensures that you are charged only for calls using your phone. However, all approved cordless phones use radio signals to communicate between the base unit and cordless handset units. It is therefore possible that your conversations could be overheard by other people, on their cordless phones, or on radios that use the same radio frequencies.

As this problem applies equally to all similar cordless phones currently available in the UK, call privacy cannot be guaranteed. However, the security coding prevents unauthorised use of your line.

In the unlikely event of your Freestyle 1025 picking up conversations from other cordless phones being used nearby, try changing channels using the **CHANNEL** button on the handset.

Transmission frequencies

This cordless telephone has been designed to operate on radio frequencies which have been assigned to the exclusive use of cordless telephones. As the use of cordless telephones becomes more widespread, the quality of service obtained from this apparatus may lessen.

Transmission frequencies of available channels:

<i>Channels</i>	<i>Base Unit Tx Freq./MHz</i>	<i>Handset Tx Freq./MHz</i>
1	31.0375	39.9375
2	31.0625	39.9625
3	31.0875	39.9875
4	31.1125	40.0125
5	31.1375	40.0375
6	31.1625	40.0625
7	31.1875	40.0875
8	31.2125	40.1125

Safety advice

Don't use your Freestyle 1025 in the open air during thunderstorms. Unplug it from the telephone line and the mains socket when there are storms in your area.

Don't use your Freestyle 1025 outdoors in the rain, or handle it with wet hands.

Don't install the base unit near a sink, bath or shower. Electrical appliances can cause serious injury if used when you are wet or standing in water.

Don't install the base unit where the various leads can be tripped over or walked on. This may cause injury, or damage to the leads and your Freestyle 1025.

In the event of a power failure

In the event of a mains power failure you will not be able to make or receive calls from your Freestyle 1025. Alternative arrangements should be made for access to emergency services.

Maintenance

Installing a handset battery pack and recharging

Replacing the handset on the base unit to recharge overnight should keep the Freestyle 1025 operative for normal use. In time, the handset battery pack will no longer hold a sufficient charge and should be replaced.

To change the handset battery pack

The handset battery compartment is located at the back of the handset at the lower end.

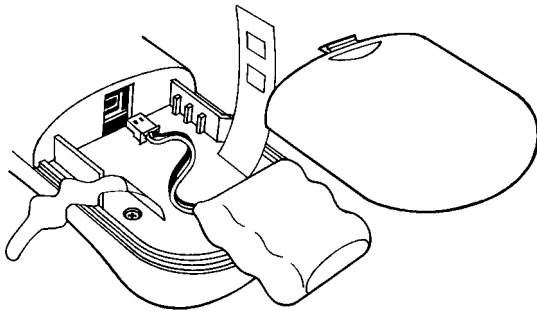

- Firmly hold the handset in both hands with the back towards you and the bottom end away from you.
- To remove the battery compartment cover, push the depression inward and away from you with both thumbs.
- Undo the plastic belt securing the battery pack.
- Remove the old battery pack by unplugging the small white plug that connects it to the handset.
- Insert the small white plug of the new battery pack. (If you look at the shape of the plug and socket, you will see that it can only be inserted one way).
- Place the battery pack in the recess, secure it with the plastic belt and refit the compartment cover.
- Replace the handset on the base unit and charge for a full 24 hours.
- The battery pack must be recycled or disposed of properly.
- Do not burn or puncture as it could release toxic material which may cause injury.

Spare parts for your Freestyle 1025 are available from your BT shop or supplier.

Care of rechargeable battery pack

- When you first install the Freestyle 1025, or replace the battery pack, the handset must be fully charged for 24 hours before use.
- To maintain optimum charge and battery condition, the handset should be allowed to fully discharge about every 4 months.
- Dispose of Ni-Cad battery packs safely. Do not puncture or burn them. They contain toxic materials which could cause injury.

General cleaning

Clean the cabinet of the handset and the base with a soft cloth slightly dampened with a mild solution of water and detergent. Charging contacts should be cleaned with a dry cloth, or for heavy soiling a pencil eraser can be used.

- Do not clean with a wet cloth.
- Do not clean with abrasive materials or solvents as these may damage the unit.
- Do not spray aerosol cleaners onto the base or handset.

Extended periods of non-use

It is recommended that you:

- Disconnect the base unit from both mains supply and telephone line.
- Remove the battery pack from the handset.
- When reconnecting, check that the charging light on the base unit is on. Recharge the handset battery for 24 hours.

Guarantee

If you own your Freestyle 1025 under BT's guarantee

BT guarantees the product for one year provided that:

The goods have only been used for their intended purpose and have not been subjected to misuse, or been wilfully or accidentally damaged.

The goods have not been tampered with or repaired by anyone other than BT, its staff or agents. If a fault does occur in this product, and you bought the unit yourself, provided that you return it to the place of purchase and produce your receipt, it will either be repaired or replaced free of charge. The terms and conditions of this guarantee do not affect your statutory rights.

If you own your Freestyle 1025 outside the guarantee period

If your Freestyle 1025 needs repair after the guarantee period has ended, it must be repaired so as to remain compliant with the approval requirements for connection to the telephone network. We recommend that you call BT on **Freefone 0800 800 150** or visit your nearest BT shop and you will be informed of our recommended repair agents.

Wall mounting

Your Freestyle 1025 can be wall-mounted by using the bracket provided.

You can use the bracket as a template to mark where the screws should go into the wall.

Please refer to page 39, wall-mounting template.

Before you wall-mount your Freestyle 1025, check that:

- the wall can support the weight of the base unit and handset;
- the position you choose leaves enough space so that the base unit (which is larger than the bracket) is clear of any obstruction on the wall, such as a shelf or cupboard. Room should be left so that the handset can be placed on charge without touching any obstructions;
- the position leaves enough space for the aerial to be extended when wall-mounted.

For the best operating conditions, try to place the base unit away from large metal objects and other electrical appliances.

- 1 Drill 2 holes for the screws and insert the wall-plugs provided (if required).

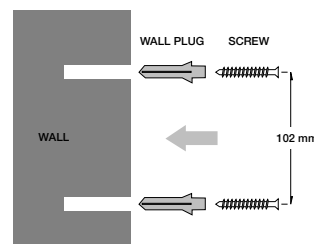

- 2 Drive the screws into the wall, leaving about 4mm free on which to mount the bracket and base unit.
- 3 Make sure that the power supply and the telephone cables are connected to the base unit, then fit the cables into the channels on the bottom of the base unit.
- 4 Clip the bracket onto the base unit as shown on the next page.

- 5  Attach the bracket and base unit by hooking them over the screws protruding from the wall.

Wall-mounting template

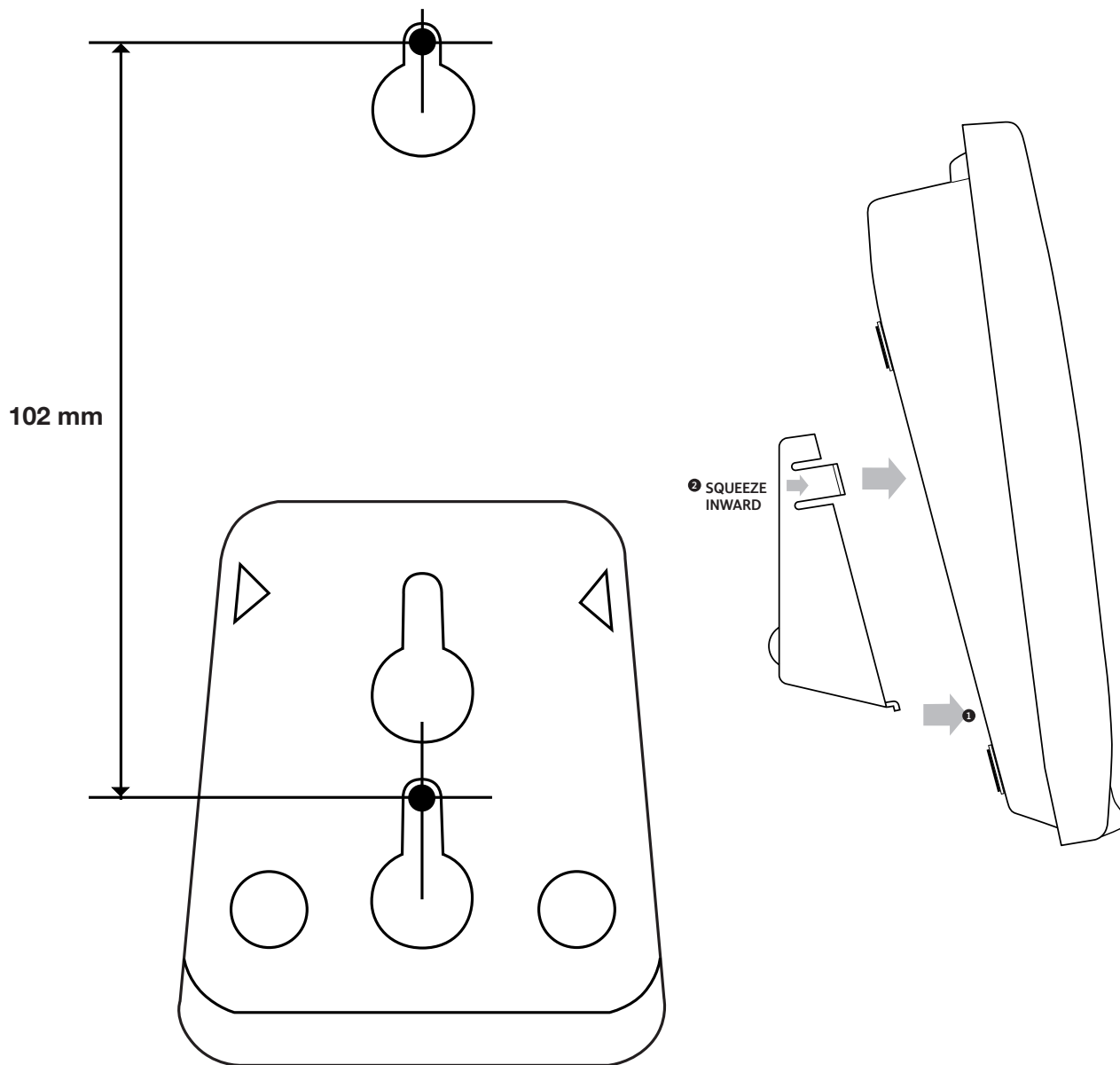

Index

Additional handsets		
basic use	29	
end a call	29	
erase	27	
handset number	28	
identity number	28	
make a call	29	
re-register	28	
register	27	
transfer a call	29	
Aerial		
base unit	7	
handset	5	
Answer delay	19	
changing	19	
checking	19	
Answering machine -		
call screening	23	
day and time	16	
delete cancel	19	
delete message	18	
delete all messages	19	
go back to pre-set outgoing message	16	
message display on base station	14	
on/off	15	
outgoing message – change	14	
outgoing message – check	15	
outgoing message – delete	16	
outgoing message – pause	18	
outgoing message – play	18	
outgoing message – pre-record	16	
record via the handset	15	
skip message	18	
volume (base station)	17	
Battery		
care of handset battery		6, 36-37
charging handset battery		6
Calls		
ending		8
making		8
range		9
receiving		8
redialling		8
secrecy		9
sound quality		9
Call screening		23
at the base		23
at the handset		23
Call waiting		12
Channel		9, 35
Charging handset battery		6
Cleaning		37
Day and time		16
Dialling mode		13
Display - answer machine		14
Display messages		14
Emergency calls		4
Guarantee		37
Help		30
Helpline		4
Incoming messages		17
Location		7
Mains adaptor		5
Maintenance		36
Making a call		8
Memory full		14
Memos		24
recording		24

Message alert	20	Wall-mounting	38
Message display	14	Wall mounting template	39
Messages – incoming	17	1471 feature	12
pause	18		
playback	18		
skip forward/backwards	18		
On/off – answering machine	25		
Pause	13, 18		
Phone socket	7		
Power adaptor	6		
Power failure	35		
Power socket	6		
Quickdial	9		
dial	10-11		
page	13		
pause	13		
store	9, 10		
Quickdial reference label	10		
Range	9		
Recall	13		
Remote access	25		
operate your answer machine	26		
check your messages via the handset	25		
REN (Ringer Equivalence Number)	34		
Safety advice	35		
Secrecy	9		
Security PIN code	23		
Sound quality	9		
Store a number in the memory	9		
Switchboards	13, 34		
Technical information	34		
Telephone socket	5		
Transmission frequencies	35		
Volume	11		
base station	11		
handset ringer melody	11		
incoming messages	11		
handset ringer	11		



*Offices in Europe, North America,
Japan and Asia Pacific.*

The telecommunications services described in this publication are subject to availability and may be modified from time to time. Services and equipment are provided subject to British Telecommunications plc's respective standard conditions of contract. Nothing in this publication forms any part of any contract.

© British Telecommunications plc 1999.
Registered Office: 81 Newgate Street, London EC1A 7AJ.
Registered in England No. 1800000.
Designed by: The Art & Design Partnership Limited.
Printed in China by: Suncorp Technologies
Freestyle 1025 Issue 1 (10/99) 2.

Printed on paper which meets international environmental standards



CE compliant to 89/336/EEC
(EMC Directive) & 73/23/EEC
(Low Voltage Directive)

APPROVED for connection to
telecommunication systems specified in
the instructions for use subject to the
conditions set out in them



610235