



UK's best selling phone brand†

Quick Set-up and User Guide



BT2100
Digital Cordless Phone

Important – please read first

- Only use the line cord, power supply and rechargeable batteries supplied with your phone.
- Make sure that the power supply is connected to a known working socket.
- Connect your phone to the power supply and allow the batteries to charge for 24 hours before connecting the line cord to your telephone socket.
- To make sure you get the best range and reception from your handset, avoid interference by placing the base unit away from large metal objects such as fridge freezers and microwave ovens or electronic products such as computers and TVs.

Check box contents



Handset



Base

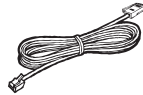

Telephone line cord
(pre-installed)



Mains power adaptor
(item code 066270)



2 x AAA Ni-MH 550 mAh
rechargeable batteries
(already in handset)

Contents for each additional handset (multipacks only)



Handset



Charger



Mains power adaptor
(item code 066270)



2 x AAA Ni-MH 550 mAh
rechargeable batteries
(already in handset)

! IMPORTANT

Only use the mains power adaptors, cables and rechargeable batteries supplied in this box or this product might not work. Any replacement rechargeable batteries must be of the same type. BT accepts no responsibility for damage caused to your BT2100 if you use any other type of batteries.

Quick set-up guide

Where to put your phone

- Place the base within 3 metres of a mains power socket and 1.8 metres of a phone socket so the cables will reach.
- Make sure it's at least a metre away from other electrical appliances to avoid interference.
- Don't place the phone or base in a bathroom or other humid area.
- The product works by sending radio signals between the handset and base. The strength of the signal depends on where you position the base. Putting it as high as possible can help give you the best signal.

IMPORTANT

- Don't connect the phone line to a phone socket until the handset is fully charged.
- The base station should be plugged into the mains power socket all the time.

1 Plug in

1. Plug the mains power adaptor into the base, with the cable clipped in the groove provided.
2. Plug the other end of the power adaptor into the wall power socket and switch on.

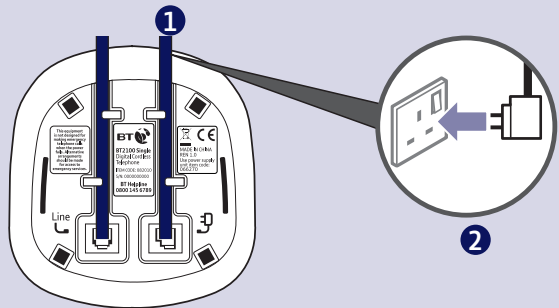



The phone line cord is pre-installed but **don't** plug the other end into the wall socket yet.

2 Activate the batteries and follow the Set-up wizard

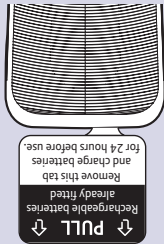
1. Activate the batteries by pulling the plastic tab away from the bottom of the handset.



2. The handset will check for a link with the base station, once found the screen will show **Please set the time and date**. The set-up wizard will take you through the steps for setting the time and date and adding contacts.

Press the Left option button  if you want to follow the set-up wizard prompt or the Right option button  button to continue to the next prompt until set-up is complete.

Talk/Standby time

Under ideal conditions, the handset batteries should give up to 12 hours talk time or 240 hours standby on a single charge. (This doesn't mean you can unplug the base or leave the handset for this length of time without charge).

Please note that new Ni-MH rechargeable batteries don't reach full capacity until they've been in normal use for several days.

Battery low warning

The  icon will flash, you'll see the message **Battery Low** in the display and hear a warning beep every minute, to indicate that you need to recharge your handset before you can use it.

You can remove the display message by selecting **Hide**. If the battery charge completely runs out, the display will show **Batteries flat. Please charge**. You must recharge the handset batteries before you can use the handset. If the charge completely runs out the handset will switch off. Place the handset on the base or charger to charge.

6 Quick set-up guide

Battery performance

- To keep the batteries in the best condition, leave the handset off the base for a few hours at a time.
- Running the batteries right down at least once a week will help them last as long as possible.
- After charging your handset for the first time, subsequent charging time for the batteries is approximately 8 hours.
- The charge capacity of rechargeable batteries will go down over time, which will reduce the talk and standby time. Eventually they'll need replacing. For details on how to get replacement batteries, call the helpline on 0800 145 6789*.

3. Once set-up is complete your handset will display **Please check line cord**, place the handset on the base to charge.
4. After 24 hours, plug the phone line cord into the phone wall socket.

! IMPORTANT

Charge the handset batteries for 24 hours or your phone might not work.

Set up your additional handsets (multipacks only)

1. For additional handsets and chargers: plug the mains power adaptor into the underside of the charger and plug the other end into the mains wall socket and switch on the power.

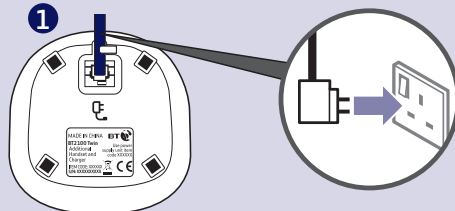

2. Activate the batteries as explained on page 5.
3. Place the handset on the charger to charge for 24 hours.

! If you ever need to remove the batteries, place your finger in the groove at the bottom of the handset and lift the cover up to release it. Then, gently ease the batteries out.

3 Go!

Your BT2100 is now ready for you to use

- For help setting the date and time, go to page 44.
- For instructions on making a call, go to page 18.
- For help personalising your phone's settings, go to page 36.

Or, you may find the answer in the Help section on page 54 or see our online frequently asked questions at bt.com/producthelp. Alternatively, call the Helpline on 0800 145 6789*.

* Calls made from within the UK mainland network are free. Mobile and international call costs may vary.

Using your BT2100 on a broadband line?

If so, you need to fit an ADSL microfilter between the phone line cord and the phone socket. You can get BT ADSL microfilters from bt.com/shop

If you cannot find the answer to your problem in this user guide, then please call our free Helpline on 0800 145 6789*. Our dedicated advisors are more likely to be able to help you than the retailer where you made your purchase.

In this guide

Getting to know your phone

Base.....	11
Handset buttons.....	12
Handset display/display icons.....	14
Finding your way around your phone	15
Menu map.....	16

Using the phone

Switch the handset on or off.....	18
Make an external call.....	18
Preparatory dialling.....	18
End a call.....	18
Receive a call.....	19
Call Waiting.....	19
Mute.....	20
Incoming speech/Handsfree volume	20
Handsfree.....	20
Make a handsfree call.....	20

Answer a call handsfree.....	21
Switch to handsfree during a call.....	21
Redial.....	21
Voicemail (1571).....	21
Call control and the Do not disturb feature.....	22
Turn Do not disturb on or off.....	22
Keypad lock.....	23
Turn the handset ringer on or off.....	23
Finding handset (paging).....	24

Contacts

Store a contact name and number.....	25
Character map.....	26
View/dial a contact.....	26
Edit a contact entry.....	27
Delete a contact entry.....	27
Delete all contacts.....	28

View the contact memory status.....28

Copy a contact (only available if you have more than one handset)29

Copy all contacts (only available if you have more than one handset)30

Speed dial

Save a speed dial entry.....31

Dial a speed dial entry32

Edit a speed dial entry32

Delete a speed dial entry32

Caller Display and the Calls list

Caller Display.....33

Calls list.....33

View/dial an entry in the Calls list.....34

Save a Calls list entry to your contacts34

Delete an entry in the Calls list35

Delete the entire Calls list35

Settings

Set the handset ringtone for external or internal calls36

Set the handset ringer volume36

Turn the handset tones on or off37

Change the handset name38

Change the handset display contrast .38

Change the call settings39

Set the base ringtone39

Set the base ringer volume40

Set a PBX access code40

Change the system PIN.....41

Reset the handset or base settings42

Reset the handset or base user data .42

Turn eco mode on or off43

10 In this guide

Clock/Alarm

- Set the time format (12 or 24 hour) ..44
- Set the time and date44
- Set an alarm45
- Stopping the alarm when it goes off..45

BT Calling Features

- Pre-stored numbers in the Calling Features menu.....46
- Using Call Diversion.....47
- Using Ringback.....47
- Using Call Waiting48
- Using Reminder call48
- Using Call Barring49
- Using Anonymous call reject.....49

Using additional handsets

- Register an additional handset.....50
- De-register a handset51

- Make an internal call between handsets.....52
- Transfer a call.....52
- Hold a 3-way call.....53

Help54

General information

- Safety information58
- Cleaning.....59
- Environmental.....59
- How to recycle your equipment59
- Guarantee60
- Technical information.....61
- Connecting to a switchboard61
- Recall (R).....61
- R&TTE.....61
- Declaration of Conformance61

Getting to know your phone

Base

Find

Press to ring all registered handsets, helpful for finding a missing handset, see page 24.

Also used during the registration process, see page 50.

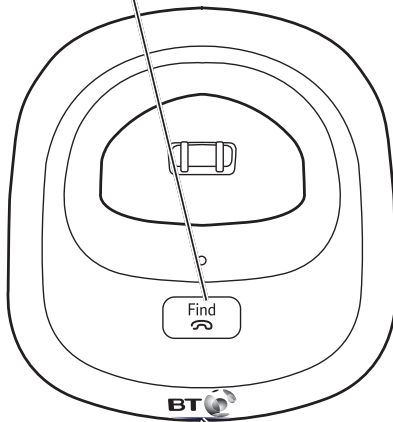

In use / Charging light

Blue light is on and flashes when phone rings or the handset is in use.

Handset buttons

Left option button

Press to enter the main menu, access sub menus and confirm options shown on the display above the button.

Vol/Up

In standby, press to change the ringer volume.

In talk mode, press to increase the incoming speech volume.

In menu mode, press to scroll up through the options.

Contacts

Press to access your stored Contacts.

Talk/Handsfree

In standby mode, press to make and receive calls, see page 18.

In talk mode, press to switch handsfree on and off, see page 20.

Calls/Down

In standby, press to open and scroll through the Calls list, see page 33.

In talk mode, press to decrease the incoming speech volume.

In menu mode, press to scroll down through the options.

1 (Speed dial)

In standby, press and hold to dial BT 1571 or your stored speed dial number, see page 21.

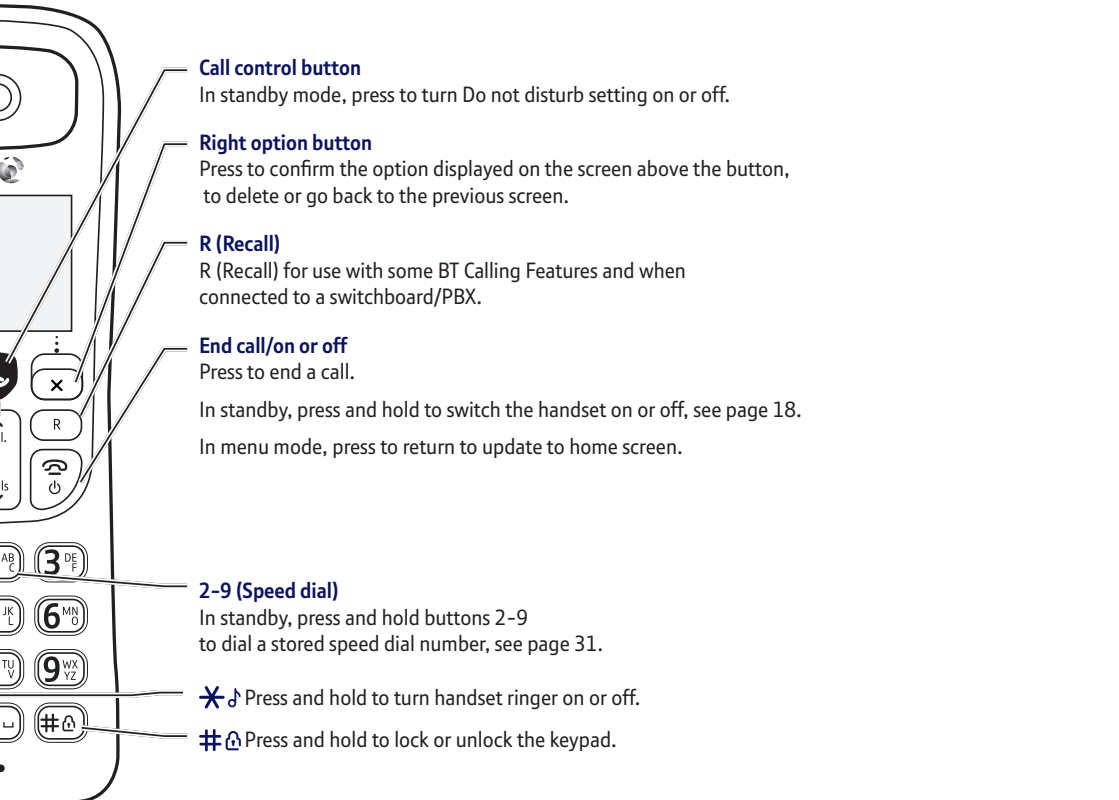

**Call control button**

In standby mode, press to turn Do not disturb setting on or off.

Right option button

Press to confirm the option displayed on the screen above the button, to delete or go back to the previous screen.

R (Recall)

R (Recall) for use with some BT Calling Features and when connected to a switchboard/PBX.

End call/on or off

Press to end a call.

In standby, press and hold to switch the handset on or off, see page 18.

In menu mode, press to return to update to home screen.

2-9 (Speed dial)

In standby, press and hold buttons 2-9 to dial a stored speed dial number, see page 31.

✖ Press and hold to turn handset ringer on or off.

Press and hold to lock or unlock the keypad.

Handset display

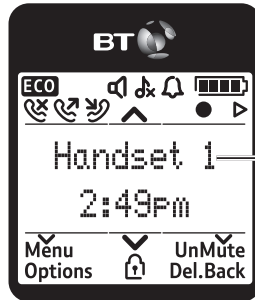

Handset name

Handset display icons

- Shows handset battery status. Scrolls when the handset is charging.
- Empty frame flashes when battery needs recharging.
- On – missed call in the Calls list*.
- On - incoming call received.
- On - outgoing call made.
- On – handsfree speaker on.
- On – Eco mode is on.

- The keypad is locked.
- Handset ringer is switched off.
- On – alarm is set.
Flashing – alarm time has been reached.
Off – alarm off.

- UnMute/Mute** Indicates when Mute is on or off.
- When on, indicates that you are listening to recorded memos.
- When on, indicates that you are recording a memo.







* For full details of who has called you please make sure you have subscribed to Caller Display from your network provider. A fee may be payable. **Find out more at bt.com/callingfeatures**

Finding your way around your phone

Your BT2100 has an easy to use menu system.

Each menu has a list of options, which you can see on the menu map on the next page.

When the handset is switched on and at the home screen:

1. Select **Menu** by pressing the Left option button  to open the main menu.
2. Use the  or  button to scroll through the available menu options.
3. When the menu you want is displayed, press the Left option button .
4. Use the  or  button to scroll through the available sub menu options.

When the sub menu you want is displayed, press the Left option button .

Select **Back** by pressing the Right option button .

To exit a menu and return to the home screen, press .

If no buttons are pressed for 30 seconds, the handset returns to the home screen automatically

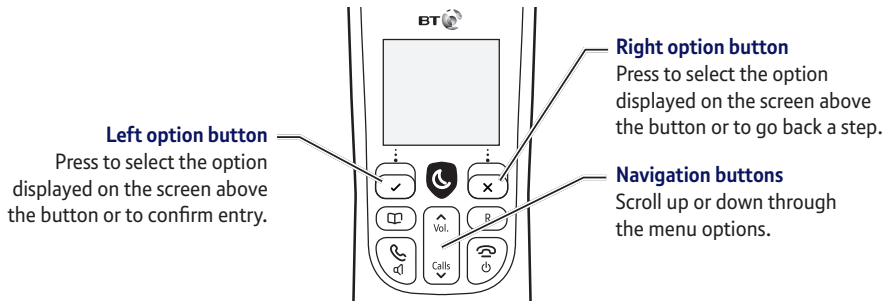

16 Getting to know your phone

Menu map

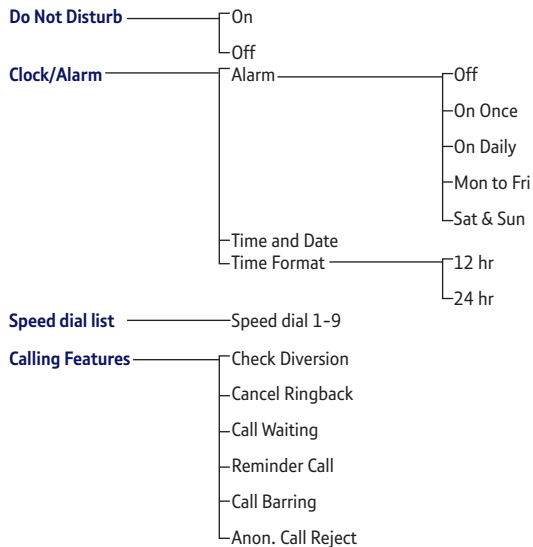

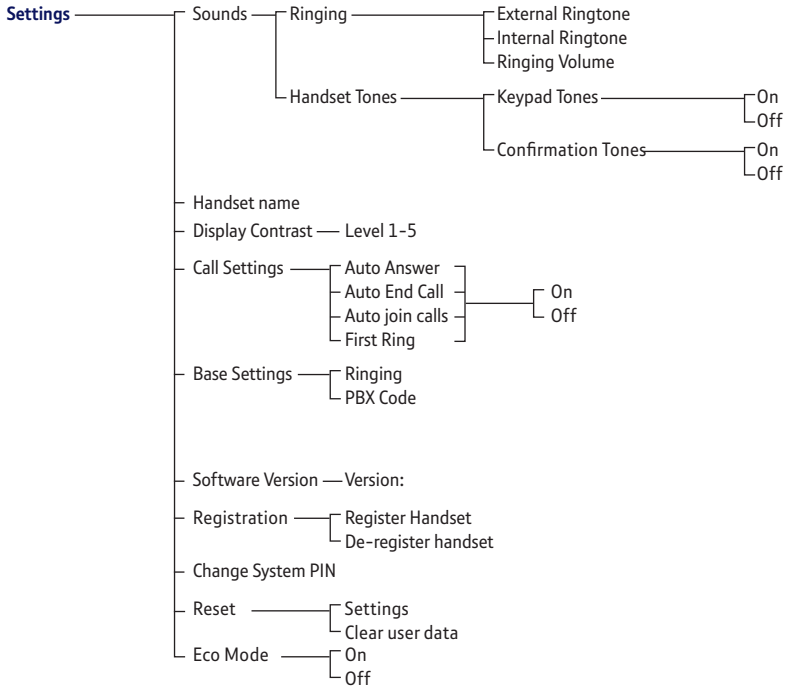

Contacts menu
 Accessed by pressing
 the  button

- Add new contact
- Edit Contact
- Delete Contact
- Copy contacts (only available if more than one handset registered)
- Memory Status
- Delete all contacts

Calls menu
 Accessed by pressing
 the  button

- Save Number
- Delete Call
- Delete All

Using the phone

If you switch the phone off and on again, the phone will need to be charged for some time, before the true charge status can be recalculated by the phone and accurately displayed.

Call timer

Your handset will automatically time your outgoing and incoming calls. The handset shows the length of time both during and for a few seconds after your call.

When you make a call, the In use light on the base comes on.

Auto end

If auto end is set to On you can end a call by placing the handset back in the base. If auto end is set to Off, you'll need to press  to end the call. Auto end On is the default setting. See page 39.

To switch the handset off

1. Press and hold  until the handset turns off.



To switch the handset on

1. Press and hold  until the handset turns on.

Make an external call

1. Press .
2. When you hear the dial tone, enter the number.

Preparatory dialling

1. Enter the number first. If you make a mistake select **Del.** by pressing the Right option button  to delete the last digit.
2. Press  to dial.

End a call

1. Press .





Receive a call

When you receive a call, the phone rings and the display shows **Incoming call** and . If you've got a caller display service, the display shows the caller's number if it's available or the caller's name if it matches an entry stored in your contacts list.

1. Press  to accept the call.

Call Waiting

If you've got a call waiting service and it is switched on, your phone will alert you to a second incoming call if you're already engaged on an external call.

1. You'll hear the call waiting tone and if you also have caller display the display will show the number of the caller, or the name if it matches an entry in your contacts.
2. Press  or select **Switch** by pressing  to answer the new call and your first caller is put on hold.
3. Press  or select **Switch** by pressing  to toggle between the two callers.
4. Press  to hang up the current call.
5. If you hang up a current call, your phone will ring back to reconnect you to your original call if that caller is still connected.

Auto answer

If auto answer is set to On you can answer a call by lifting the handset off the base.

If auto answer is set to Off, you'll need to lift the handset off the base and press  too. Auto answer On is the default setting. See page 39.

Call Waiting

To switch your call waiting service on or off, see page 48.

Out of range warning

When the handset is out of range of the base, the display will show **Searching for base...**, the backlight will turn up to 100% to indicate the alert message and you will hear a warning tone. You need to move back within range of the base station.

If you move out of range when you're on a call, you'll lose your connection. The handset will automatically re-connect to the base when you move back within range.

20 Using the phone

During a call, you can talk to someone nearby without your caller hearing.

Mute can also be used to silence a handset ringer when an incoming call is received.

During a call, you can adjust the handset incoming speech or loudspeaker volume. There are five levels. The default setting is Level 3.

Handsfree



Handsfree lets you talk to your caller without holding the handset and means that other people in the room can listen to your conversation over the loudspeaker.

During a handsfree call, press  or  to change the volume.





Mute

1. During a call, select **Mute** by pressing the Right option button. The display shows **Call muted** and your caller can't hear you.
2. Select **UnMute** to return to your caller.

Incoming speech / Handsfree volume

1. Press  or  to increase or decrease the volume. The first press will present the Call volume screen so you can see the current volume level. Subsequent presses will change the volume, you will hear the volume level with each press.

Make a handsfree call



1. Enter the number then press  twice.  is displayed. You hear your call over the handset loudspeaker. Press  to switch the call between the earpiece and the loudspeaker.
2. Press  to end the call.

Answer a call handsfree

When the phone rings:

1. Press  after the call has been answered. The call is transferred to the handset loudspeaker.

Switch to handsfree during a call

1. During a call, press  to put the call on the loudspeaker. To switch handsfree off and return the call to the earpiece, press  again.

Redial

Telephone numbers that you have called are saved in the Calls list. There is not a separate redial list, all calls are saved in the Calls list. The Calls list holds up to 50 incoming (missed and answered) calls and 20 outgoing calls.

To redial a number, see 'View/dial an entry in the Calls list' on page 34. You can also save a number to your contacts, delete a number or delete all numbers from the Calls list, see pages 34-35.

Voicemail (BT 1571)







1. If you have subscribed to BT Answer 1571 you can press and hold  to listen to your messages.

When set to On, the idle screen will display **Do Not Disturb**.

Call control and the Do not disturb feature



The Do not disturb feature allows calls to be presented silently with minimal notification. When set to On, the base and handset ringer volumes (on all handsets registered to the base) will be set to Off. The handset backlight will not come on when the phone rings and the only tones that the handset will emit are the battery low and out of range warnings.

Turn Do not disturb on or off

1. From the standby screen, press the  button to turn On or Off. The current setting will be displayed and you will hear a confirmation tone.
Or, using the menu:
 1. Select **Menu**, scroll  to **Do Not Disturb** and press .
 2. Press  or  to select On or Off then press  to save. The chosen setting will be displayed and you will hear a confirmation tone.

Keypad lock



To lock the keypad

1. Press and hold  for 2 seconds. The handset gives a confirmation tone and **Keypad locked** is briefly displayed before returning to the home screen, with the  icon displayed.

To unlock the keypad:

1. Press and hold  for 2 seconds. The handset gives a confirmation tone and **Keypad unlocked** is briefly displayed before returning to the home screen.

Turn the handset ringer on or off

1. Press and hold  for 2 seconds to turn the handset ringer on or off. The display will briefly show **Ringer on** or **Ringer off** before reverting to the home screen with the  icon displayed if the ringer is off.

You can lock the keypad so that it can't be used accidentally while you're carrying it around.

With the keypad locked, you can still call the emergency services on 999 and 112 using preparatory dialling and you can still answer incoming calls and operate the in call features as normal. When the call is ended, the  comes on again.

24 Using the phone



If you get an incoming call while you're paging a handset, the incoming call takes priority.

If the handset ringer is switched off on a handset, it will be temporarily switched back on so the handset can be found.

Paging calls can't be answered by a handset.

Find handset (Paging)







You can ring a handset to help find it.

1. Press  on the base. All handsets registered to the base will ring and the screen will show `Base searching for handsets` for up to 2 minutes.
2. To stop the ringing, press  on the base again or press  on any handset.



Contacts

You can store up to 50 names and numbers in your list of contacts. Names can be up to 14 characters and numbers up to 24 digits. The handset will come with some special numbers pre-stored. These will include the BT Helpline, BT 118500, All handsets (if you have more than two handsets registered) and a list of the handsets registered to the base according to their default name/number (e.g. Handset 2 or 3 etc) or name if you have stored one.

Store a contact name and number

1. From the home screen, press .
2. Select **Options** by pressing . Add new contact will be displayed, press .
3. Enter the new contact name using the keypad (see note opposite for help) and press .
4. Enter the phone number and press . The display will show **Contact saved** and you will hear a confirmation tone.
5. If you only have one handset, the display will return to the contacts list showing the new entry. If you have more than one handset registered to the base you will be prompted to **Copy to other handsets?** If you wish to, press  and follow the display instructions or see page 29.

Entering names

Use the keypad letters to enter names, e.g. to store Tom: Press  once to enter T. Press  three times to enter o. Press  once to enter m.

Writing tips

To delete the last digit/character entered, select **Del.** by pressing the  button.

Press  to switch between text entry modes: sentence case (Abc), upper case ABC, lower case (abc) or numeric (123).

Press  to insert a space.

To enter a pause in a contact number



When storing a number, press and hold  in the place where you want the pause.

To enter a recall in a contact number

When storing a number, press and hold  in the place where you want the recall.

Searching alphabetically





Press the relevant keypad button, e.g. to search for a contact beginning with S, press

 four times, then scroll  through the entries.











Character map

1	& . , ' ? ! @ 1
2	a b c 2 à á â ã æ ç
3	d e f 3 è é ê ë
4	g h i 4 î ï ï
5	j k l 5 £
6	m n o 6 ô õ ò ó õ ø ñ
7	p q r s 7 \$ ß
8	t u v 8 ü ù ú û
9	w x y z 9
0	space 0 + £ \$ # *
*	*
#	Changes text entry mode (sentence case, upper, lower or numeric)







View/dial a contact

1. From the home screen, press . The first entry will be displayed.
2. Press  or  to scroll through and view the entries.
3. To dial an entry, press  when the entry is displayed.

Edit a contact entry

1. From the home screen, press .
2. Press  or  to scroll to the entry you want to edit and select **Options** by pressing Left option .
3. Press  to display Edit Contact and press .
4. Edit the name using  to delete characters and use the keypad to enter new ones, then press .
5. Edit the number using  to delete characters and use the keypad to enter new ones, then press .
6. The display will show *Contact saved* and you will hear a confirmation tone. If there is more than one handset registered to the base you will be given the choice to copy the entry to other handsets.

Delete a contact entry

1. From the home screen, press .
2. Press  or  to scroll to the entry you want to delete and select **Options** by pressing .
3. Press  until Delete Contact is displayed and press .
4. Delete contact? is displayed, press  to confirm. The display will show *Contact deleted* and you will hear a confirmation tone.

You cannot edit the special contact entries that the handset has pre-programmed in memory.





When you delete an entry, it will only be deleted on the handset you are using. If you have more than one handset registered to the base you will need to delete the entry manually from each handset.

You cannot delete the special contact entries that the handset has pre-programmed in memory.





When you delete all contacts they will only be deleted on the handset you are using. If you have more than one handset registered to the base and wish to delete all contacts from them all, you will need to manually follow the delete all contacts procedure using each handset.

The delete all contacts feature will not delete the special contact entries that the handset has pre-programmed in the memory.







Delete all contacts

1. From the home screen, press . The first entry will be displayed. Select **Options** by pressing .
2. Press  until **Delete all contacts** is displayed and press .
3. **Delete all contacts?** is displayed, press  to confirm. The display will show **All contacts deleted** and you will hear a confirmation tone.

View the contact memory status

1. From the home screen, press . The first entry will be displayed. Select **Options** by pressing .
2. Press  until **Memory Status** is displayed and press .
3. The display will show the total number of contacts stored and the total amount of contacts that can be stored, e.g. **22 contacts; (50 max.)**.



Copy a contact (only available if you have more than one handset)

1. From the home screen, press . The first entry will be displayed.
2. Press  or  to scroll to the entry you want to copy and select **Options** by pressing .
3. Press  until **Copy contacts** is displayed and press .
4. **Copy only** and the contact's name will be displayed, press .

If you only have 2 handsets registered to the base:

The display will show **Copying to** and the handset name/number you are copying to. Once the contact has been copied successfully, the display will show **Copy complete** and you will hear a confirmation tone.

If you have more than 2 handsets registered to the base:

The display will show **Copy to: All handsets**. You have the option to copy to all your handsets or to select an individual handset using  or  to display your choice, then press . Once copying has been successful you will hear a confirmation tone and the display will show **Copy complete**.

Copy all contacts (only available if you have more than one handset)

1. From the home screen, press . The first entry will be displayed, select **Options** by pressing .
2. Press until Copy contacts is displayed and press .
3. Press to display Copy all contacts and press .

If you only have 2 handsets registered to the base:

The display will show Replace contacts list?

Press , the handset name/number you are copying to will be displayed. Once the contact has been copied successfully, the display will show Copy complete and you will hear a confirmation tone.

If you have more than 2 handsets registered to the base:

Press or to display the handset you want to copy to, then press . The display will show Replace contacts list? Press , the handset name/number you are copying to will be displayed. Once copying has been successful, the display will show Copy complete and you will hear a confirmation tone.

Speed dial





You can allocate a name and number to each of the Speed dial buttons **1** to **9^{WX}_{YZ}**. Button **1** is pre-programmed with 1571 but you can delete this and replace it with an entry of your choice. Once a Speed dial entry has been stored you can simply press and hold the Speed dial button to automatically dial the number stored under it.

Save a Speed dial entry

1. From the the home screen, enter the telephone number you want to store.
2. Then, either:

Press and hold the Speed dial button **1** to **9^{WX}_{YZ}** you want to store the number under. The display will show **Saved as speed dial X** (x being the Speed dial button) and you will hear a confirmation tone.

Or,

Select **Options** by pressing . The display will show **Save as speed dial**. Press . Press  or  to display the Speed dial button number you want to save the entry under and press . The display will show **Saved as speed dial X** (x being the Speed dial button) and you will hear a confirmation tone.









If you try to save a Speed dial entry under a Speed dial button that has already been populated, the display will show **REPLACE number?** and you will hear an error tone. You can either overwrite the existing entry by pressing and holding the same Speed dial button or press and hold a different Speed dial button.

If you try to save a Speed dial entry under a Speed dial button that has already been populated, the display will show **Replace number?** and you will hear an error tone. You can overwrite the existing entry by pressing .









Dial a Speed dial entry

1. Press and hold the Speed dial button **1** to **9**^{WX}_{YZ} under which the entry you want to dial is stored. The number will be dialed automatically.

Edit a Speed dial entry

1. Select **Menu** by pressing , scroll  to **Speed dial list** and press . The first entry will be displayed.
2. Press  or  to display the entry you want to edit and select **Options** by pressing .
3. Edit **speed dial** is displayed, press .
4. Edit the number by selecting **Del.** to delete digits and then enter the new digits. Press  to save. You will hear a confirmation tone and **Saved as speed dial x** will be displayed.

Delete a Speed dial entry

1. Select **Menu** by pressing , scroll  to **Speed dial list** and press . The first entry will be displayed.
2. Press  or  to display the entry you want to delete and select **Options** by pressing .
3. Press  to display **Delete speed dial** and press .
4. **Delete speed dial x?** is displayed, press . You will hear a confirmation tone and **Speed dial x deleted** will be displayed.

Caller Display and the Calls list

Caller Display

If you've subscribed to a Caller Display service, you'll be able to see your caller's number on your handset display (provided it's not withheld) before you answer a call. If your caller's name is stored in your contacts list and it matches the number calling, you'll see the caller's name on the display instead. If you haven't subscribed to a Caller Display service **Incoming call** will be displayed when you receive a call.

Calls list

The Calls list holds up to 50 incoming (missed and answered) calls and 20 outgoing calls. The date and time of the call is also stored. If you haven't subscribed to a Caller Display service, **No number** will be displayed in the Calls list for incoming calls but the time and date will still be recorded.

Calls are listed in chronological order with the most recently received/made call at the top of the list. When the list is full and a new call is received/made, the oldest entry will be deleted automatically. The Calls list can hold numbers up to 24 digits and names up to 14 characters.

You'll need to subscribe to your network provider's Caller Display service for this feature to work. You might have to pay a fee. For more information on BT Calling Features, call BT free on 0800 800 150.

For the caller's name to be displayed, make sure you've stored the full telephone number in your contacts list, including the dialling code.

There are some incoming calls where a number is not displayed and a network message is recorded instead:

Unavail = number is unavailable

Withheld = number has been withheld

International = international number

Operator = call from the operator

Payphone = call from a payphone

Ringback = a ringback call



34 Caller Display and the Calls list

Calls list indicators



 = outgoing call made

 = incoming call received





 = missed call

When the Calls list is open, press  to scroll from the newest call to the oldest, or press  to scroll from the oldest call to the newest.





Missed call notification



The  missed call icon will be displayed on the home screen when incoming calls have been missed and the number of missed calls will be shown e.g. 10 new calls. You can clear the notification by viewing the calls list on any handset registered to the base. The  icon will still be presented for missed calls in the calls list so you can differentiate between calls. See, “Calls list indicators”, opposite.

View/dial an entry in the Calls list







1. Press . The most recent entry is at the top of the list. (If there are no entries Calls list empty will be displayed.)
2. Press  or  to scroll through and view the list.
3. To dial an entry, when the entry you want is displayed, press .

Save a Calls list entry to your contacts





1. Press , then press  or  to scroll to the entry you want and select **Options** by pressing .
2. Save number is displayed, press .



3. Enter the new contact's name using the keypad and press .
4. The number will be displayed, edit if necessary and press . Contact saved will be displayed and you will hear a confirmation tone.
5. If you have more than one handset registered to the base, the display will show Copy to all handsets? Press  if you wish to copy to your other handsets.

Delete an entry in the Calls list

1. Press , then press  or  to scroll to the entry you want to delete and select **Options** by pressing .
2. Press  to display Delete call and press . Call deleted will be displayed and you will hear a confirmation tone.

Delete the entire Calls list

1. Press , then display any entry and select **Options** by pressing the  button.
2. Press  until Delete all calls is displayed, then press . Delete all calls? will be displayed, press  to delete and you will hear a confirmation tone.

If you need to edit the number or name, press  or  to move cursor left or right and **Del.** to delete unwanted digits/characters then use the keypad to enter new ones.

Settings

Choose from 5 handset ringtones. The default external ringtone is Melody 1 and the internal ringtone is Melody 2.











There are 5 handset ringer volume levels plus Ringer Off. The default setting is Level 3.

If you turn the ringer off, the  icon will be displayed on the home screen.







As a quick way to turn the handset ringer off, press and hold .



Handset settings

Set the handset ringtone for external or internal calls











1. Select **Menu**, scroll  to **Settings** and press .
2. **Sounds** is displayed, press . **Ringtones** is displayed, press .
3. **External Ringtone** is displayed, press .
Or, press  to display **Internal Ringtone** and then press . The current ringtone will be played.
4. Press  or  to hear the different ringtones and press  to save your choice. **Saved** will be displayed and you will hear a confirmation tone.

Set the handset ringer volume

1. Select **Menu**, scroll  to **Settings** and press .
2. **Sounds** is displayed, press . **Ringtones** is displayed, press .
3. Press  until **Ringing Volume** is displayed and press .

- The current external ringtone will play at the current volume. Use the  or  button to increase or decrease the volume, or turn the ringer off. You will see the volume level change on the display or Ringer Off will be displayed if you turn the ringer off.
- Press  to save your choice. Saved will be displayed and you will hear a confirmation tone.

Turn the handset tones on or off

- Select **Menu**, scroll  to **Settings** and press .
- Sounds** is displayed, press . Press  until **Handset Tones** is displayed and press .
- Keypad Tones** is displayed, press  or press  to display **Confirmation Tones** and then press .
- Press  or  to select **On** or **Off** then press  to save. **Saved** will be displayed and you will hear a confirmation tone (if set to on).

There are two handset tones: keypad tones and confirmation tones. You can turn these on or off, the default setting is On.

Keypad tones: when turned on, you will hear a beep after each button press.





Confirmation tones: when turned on, you will hear a tone after each successful action or after an error has occurred. This does not include the battery charging tone when the handset is placed on the base/charger, low battery or out of range warnings or tones used in calls such as Call Waiting or Call Intercept.

A handset name can be a maximum of 12 characters. If you name your handset, the handset number will be removed, e.g. instead of saying Kitchen 1 the name would just be Kitchen.







To revert back to the default handset name (Handset x), delete all the characters and press .

There are 5 contrast levels to choose from. The default setting is Level 3.











Change the handset name

1. Select **Menu**, scroll  to **Settings** and press .
2. **Sounds** is displayed, press  until **Handset Name** is displayed and press .
3. Edit the name by selecting **Del.** to delete the characters, then enter the new name and press  to save. **Saved** will be displayed and you will hear a confirmation tone.

Change the handset display contrast









1. Select **Menu**, scroll  to **Settings** and press .
2. **Sounds** is displayed, press  until **Display Contrast** is displayed and press .
3. Press  or  to select the level you want, then press  to save. **Saved** will be displayed and you will hear a confirmation tone.

Change the call settings

1. Select **Menu**, scroll  to **Settings** and press .
2. **Sounds** is displayed, press  until **Call Settings** is displayed and press .
3. **Auto Answer** is displayed, press  or press  to display either **Auto End Call**, **Auto Join calls** or **First Ring** and then press .
4. Press  or  to select **On** or **Off** then press  to save. **Saved** will be displayed and you will hear a confirmation tone.

Base settings

Set the base ringtone

1. Select **Menu**, scroll  to **Settings** and press .
2. **Sounds** is displayed, press  until **Base Settings** is displayed and press .
3. **Ringing** is displayed, press . **Ringtone** is displayed, press .
4. The current ringtone will be played at the base. Press  or  to hear the different ringtones and press  to save your choice. **Saved** will be displayed and you will hear a confirmation tone.

The default setting for all call settings is **On**.

If **Auto answer** is set to **On** you can answer a call by lifting the handset off the base. If it's set to **Off**, you'll need to lift the handset off the base and then press .

If **Auto end** is set to **On** you can end a call by placing the handset back in the base.

If **Auto end** is set to **Off**, you'll need to press  to end the call and if the handset is placed back in the base it will switch to handsfree mode.

With **Auto join calls** set to **On** you can automatically join an existing call from another registered handset without being invited to join the call, you can simply press  to join.

With **First ring** set to **Off**, an incoming external call will be displayed visually before the handset(s) start to ring for the second burst of ringing.

Choose from 5 base ringtones. The default base ringtone is **Melody 1**.











40 Settings

There are 5 base ringer volume levels plus Ringer Off. The default setting is Level 3.







If you're connected to a switchboard, you might need to enter an access code (e.g.9) before each number is dialled. Your BT2100 can store an access code which is automatically dialled before each number.

If you wish to revert to not using a PBX access code, you need to go into the PBX code menu and delete all the digits by selecting Del., then press  to save.







Set the base ringer volume

1. Select **Menu**, scroll  to **Settings** and press .
2. **Sounds** is displayed, press  until **Base Settings** is displayed and press .
3. **Ringing** is displayed, press . Press  to display **Ringing Volume**, then press .
4. The current base ringtone will play at the current volume. Use the  or  button to increase or decrease the volume, or turn the ringer off. You will see the volume level change on the display or **Ringer Off** will be displayed if you turn the ringer off.
5. Press  to save your choice. **Saved** will be displayed and you will hear a confirmation tone.

Set a PBX access code

1. Select **Menu**, scroll  to **Settings** and press .
2. **Sounds** is displayed, press  until **Base Settings** is displayed and press .
3. Press  to display **PBX Code** and press .
4. Enter the number you want (maximum of 4 digits) and press  to save. **Saved** will be displayed and you will hear a confirmation tone.

Change the system PIN

1. Select **Menu**, scroll  to **Settings** and press .
2. **Sounds** is displayed, press  until **Change System PIN** is displayed and press .
3. If the current PIN is 0000, you will be prompted to enter the new 4 digit PIN, then press .
(Or, if the current PIN is not 0000, enter the old (current) 4 digit PIN first and then press .
Then follow the prompts and enter the new 4 digit PIN).
4. Enter the new 4 digit PIN again and press . The display will show **New system PIN saved** and you will hear a confirmation tone.

The default system PIN is 0000. You can change this to your own preferred 4-digit code.

The system PIN is used when changing certain settings and for registration/de-registration.

If you make a mistake, select **Del.** to delete a digit.









If you reset the handset settings all the handset settings will return to their default settings, e.g. the handset name, ringer melody, all volume levels, display and alarm settings.

If you reset the base settings all the base settings will return to their default settings, e.g. the base ringer melody, all volume levels and PBX access codes.









If you clear the handset user data all your contacts and the calls list will be deleted.



If you clear the base user data your memos and calls list will be deleted.

Reset the handset or base settings

1. Select **Menu**, scroll  to **Settings** and press .
2. **Sounds** is displayed, press  until **Reset** is displayed and press .
3. **Settings** is displayed, press . **Handset Settings** is displayed, press  or press  to display **Base Settings** and then press .
4. **Reset <handset or base> settings?** is displayed, press .
5. **Resetting settings...** is displayed while the reset takes place. Once finished, **<handset or base> settings reset** is displayed and you will hear a confirmation tone. If you reset the base settings, the welcome screen will be displayed.







Reset the handset or base user data

1. Select **Menu**, scroll  to **Settings** and press .
2. **Sounds** is displayed, press  until **Reset** is displayed and press .
3. **Settings** is displayed, press  to display **Clear user data** and press . **Handset** is displayed, press  or press  to display **Base** and then press .

4. If the system PIN is not 0000 you will be prompted to enter it, then press . If it is, you will continue straight to step 5.
5. Clear <handset or base> user data? is displayed, press .
6. Clearing user data... is displayed. Once finished, <handset or base> user data deleted is displayed and you will hear a confirmation tone.

Turn eco mode on or off

With eco mode on, the handset only uses the transmission power it needs to communicate with the base rather than full transmission power all the time.

1. Select **Menu**, scroll  to **Settings** and press .
2. **Sounds** is displayed, press  until **Eco Mode** is displayed and press .
3. Press  or  to select **On** or **Off** then press  to save. **Saved** will be displayed and you will hear a confirmation tone (if set to on).

The default setting is off.



If you have more than one handset you'll need to set eco mode on each handset individually.

Clock/Alarm

If you have subscribed to a Caller Display service the time and month will be set when you receive your first call but you will still need to set the year.

The default setting is 12 hour.







You must enter the full date: day, month and year.

Use  if you need to move the cursor left and  to move the cursor right.







The time is set in 24 hour format.

If you didn't set the time and date when you first set-up your phone then you will need to do so before you can set an alarm. The clock will also be displayed on the handset screen in idle mode.











Set the time format (12 or 24 hour)

1. Select **Menu**, scroll  to Clock/Alarm and press .
2. Alarm is displayed, press  until Time Format is displayed and press .
3. Press  or  to display 12 hour or 24 hour then press  to save your choice. Saved will be displayed and you will hear a confirmation tone.

Set the time and date



1. Select **Menu**, scroll  to Clock/Alarm and press .
2. Alarm is displayed, press  until Time and Date is displayed and press .
3. Enter the time using the keypad and press .
4. Enter the date using the keypad and press . Saved will be displayed and you will hear a confirmation tone.



Set an alarm

1. Select **Menu**, scroll  to **Clock/Alarm** and press .
2. **Alarm** is displayed, press .
3. Press  or  to display the alarm frequency you want: **Off**, **On Once**, **On Daily**, **Mon to Fri** or **Sat & Sun** and press .
4. Enter the alarm time using the keypad and press .
5. Press  or  to hear and choose the alarm melody you want, press  to confirm your choice.
6. You will hear a confirmation tone and the display will briefly show **Alarm on** and the time you have set.

Stopping the alarm when it goes off

When the alarm goes off, the selected melody will play at an ascending volume and the handset backlight will flash. The display will show the alarm time and also the message **10 min snooze?**

To stop the alarm, press  or .

To activate a ten minute snooze, press  or any other button (except  or ).

If you select **Off** and press  the display will show **Alarm off** and you will hear a confirmation tone.

When you've set an alarm, the  icon will appear on the idle screen to confirm an alarm has been set.

If an incoming call is received while the alarm is going off, the alarm notification will immediately stop and the incoming call will be shown on the display. The alarm will not resume.

BT Calling Features

You need to subscribe to the specific BT Calling Feature to be able to use some of these services. You might have to pay a fee.

For more details on BT's Calling Features, go to bt.com/callingfeatures, refer to the user guide supplied when you subscribed to the services of your choice or call BT free on 0800 800 150.

If you're not connected to the BT network, some of these features may not be available. Call diversion services might allow other divert options. Please contact your telephone network provider for details.

You can easily access a number of BT Calling Features using the Calling Features menu. There are two empty entries in the menu where you can store your own numbers if you wish to.

Pre-stored numbers in the Calling Features menu

Call Diversion

Cancel Ringback









Call Waiting

Reminder Call





Call Barring

Anon. Call Reject

Using Call Diversion: Set All Calls, When Busy or When Unanswered

1. Select **Menu**, scroll  to **Calling Features** and press .
2. **Call Diversion** is displayed, press .
3. Press  or  to display either **Divert all calls**, **Divert when busy** or **Divert if unanswered** and press .
4. Press  or  to display either: **Setup diversion**, **Cancel diversion** or **Check diversion** and press . Follow the spoken instructions or listen for confirmation/status.

Using Ringback

1. Select **Menu**, scroll  to **Calling Features** and press .
2. Press  until **Cancel Ringback** is displayed, press .
3. Follow the spoken instructions or listen for confirmation/status.

Call Diversion will divert incoming calls to another number of your choice. You can choose all calls to be diverted or calls only to be diverted when the line is busy.

When 'Setup diversion' is selected, you will be prompted to enter the number you wish to divert calls to then press the left option key . Follow the spoken instructions or listen for confirmation/status.

With the ring back feature you can get an automatic call back from an engaged number. No need to dial a busy number over and over again. Just dial 5, wait for a confirmation message and hang up. Your phone will keep trying the busy number for up to 45 minutes.







48 BT Calling Features

Call Waiting lets you know if another person is trying to call you while you're on another call. If a second caller rings, you will hear a beep in the handset earpiece. If you've subscribed to Caller Display, the display will show the caller's details as well.

Reminder call lets you book an alarm call. Like an alarm clock, except it lets you book an alarm call days in advance. Set repeat reminders every day or as a one-off call to remind you of a specific event.







When 'Set up Reminder call' is selected, you will be prompted to enter the time you wish to receive the reminder call and then press the left option key . Follow the spoken instructions or listen for confirmation/status.

Using Call Waiting

1. Select **Menu**, scroll  to **Calling Features** and press .
2. Scroll  to **Call Waiting** and press .
3. Press  or  to display either **Turn on Call Waiting**, **Turn off Call Waiting** or **Check Call Waiting** and press .







Follow the spoken instructions or listen for confirmation/status.

Using Reminder call







1. Select **Menu**, scroll  to **Calling Features** and press .
2. Press  until **Reminder Call** is displayed, press .
3. Press  or  to display either: **Set up Reminder Call**, **Cancel Reminder Call** or **Check Reminder Call** and press .

Follow the spoken instructions or listen for confirmation/status.

Using Call Barring

1. Select **Menu**, scroll  to Callings Features and press .
2. Press  until Call Barring is displayed, press .
3. Press  or  to display either: Set up Call Barring, Cancel Call Barring or Check Call Barring and press . Depending on which option you choose, select the next option you want or listen for confirmation/status.

Using Anonymous Call Reject

1. Select **Menu**, scroll  to Callings Features and press .
2. Press  until Anonymous Call Reject is displayed, press .
3. Press  or  to display either: Turn on Call Reject, Turn off Call Reject or Check Call Reject and press  to call. Follow the spoken instructions or listen for confirmation/status.

If you selected Set up Call Barring, you have the following options:

Bar all outgoing calls, Bar Int, Nat & Mobile calls, Bar Int calls, Bar operator calls & texts, Bar calls using * and # or Bar premium rate calls.

If you selected Cancel Call Barring, you have the following options:

Cancel barring for all calls, Cancel barring Int/Nat/Mob, Cancel barring Int calls, Cancel barring operator/texts, Cancel barring* and # calls or Cancel barring premium rate.

Anonymous call reject blocks calls from withheld or anonymous numbers. If a caller withholds their number, they won't be able to get through to you.

Using additional handsets

You can register up to five GAP compliant handsets to your BT2100 base to extend your phone system without needing to install telephone extension sockets for each new phone.

If a handset becomes un-registered it will need to be registered to the base again. Register handset? will be displayed, press  then follow the instructions starting from point 4 opposite.









You have 2 minutes to complete the registration process.

If registration isn't successful the first time, please try again incase the base registration period ran out of time.











If there are already five handsets registered to the base, the registration will fail. You must de-register another handset before you can register the new one, see page 51.

If you've bought a BT2100 multiple pack, any additional handsets come pre-registered to the base. However, if you purchase an additional handset separately, you must register it to your BT2100 base before it can be used.

Register an additional handset

1. Select **Menu**, scroll  to **Settings** and press .
2. Press  until **Registration** is displayed and press .
3. **Register Handset** is displayed, press .
4. Press & hold **find** on base is displayed. Press and hold the  button on the base for 5 seconds. The green **In use** light on the base will start to flash.
5. Immediately, press  on the handset. The handset will display **Registering handset** to indicate the base is in registration mode. If the system PIN is not 0000 then you will be prompted to enter it, then press .
6. Once registration is successful the handset will show **Handset x registered** (with X being the assigned handset number) and you will hear a confirmation tone.

De-register a handset

1. Select **Menu**, scroll  to **Settings** and press .
2. Press  until **Registration** is displayed and press .
3. Press  to display **De-register handset** and press .
4. Press  or  to display the handset you wish to de-register and press .
5. If the system PIN is not 0000 then you will be prompted to enter it, then press . If it is 0000, you will continue straight to point 6.
6. The display will show **De-registering handset** and once successful, you will hear a confirmation tone and the display will confirm the handset has been de-registered.

Registering another make of handset to your BT2100 base

If you want to register another make of handset (i.e. not a BT2100 handset) to your BT2100 base you will need to follow the Registration instructions that came with the handset first and then continue with the base part of the registration procedure (as shown in point 4 on page 50). Please note that registering other types of handset will only provide limited compatibility i.e. you may only be able to make and receive calls on the additional handset.

52 Using additional handsets

You can also choose **All handsets** if you want to call all handsets registered to the base. If a handset answers, the handset name will be displayed on your screen.





If an external call is received while an internal call is being made, the handsets registered to the base will display the external call information and you will hear the call waiting tone in the handset earpiece.

You can also choose **All handsets** if you want to call all handsets registered to the base. If a handset answers, the handset name will be displayed on your screen.

If the internal call is not answered after 30 seconds you will see **Handset not available** on your display and you will be returned to your external caller.







Make an internal call between handsets

If you have more than one handset registered to the base, you can make internal calls between two handsets.

1. Press , then press  to scroll through and display the handset you want to call, then press .
2. The receiving handset will ring and your handset name will be presented on the screen. To answer they need to press . If it is not answered after 30 seconds, you will see **Handset not available** on your display.
3. Press  to end the call.

Transfer a call





You can transfer an external call to another handset registered to the base.

1. During a call, select **Options** by pressing the  button, then press  to display **Transfer call** and press .
2. If you have one other handset it will ring, if you have more than one other handset you can press  or  to display the handset you want, then press  and it will ring. Your external call will be put on hold.

3. When the other handset answers you can announce the call and then press  to transfer the call.

Hold a 3-way call

Using your handset, you can hold a 3-way call with two external callers. Or, you can hold a 3-way call between 2 handsets, if you have more than 1 registered to your base and 1 external caller. Once the 3-way call is in progress other handsets registered to the base can join the call by pressing .

1. During a call, select **Options** by pressing the  button. Multi call is displayed, press .
2. Either enter the number you want to call or press  and scroll to the number you want or the internal handset you want and then press  to call. When the second call is answered, the first external caller will be put on hold.
3. Select **Join** by pressing the  button and all callers will be joined in a 3-way call.

Help

Phone doesn't work

- Have you activated the batteries correctly? See page 5.
- Check that the mains power is correctly connected.

No dial tone or line cord error message displayed on screen

- Is the telephone cord plugged into the base and phone wall socket?
- Check that the mains power is correctly connected.
- Only use the telephone cord supplied with the phone.

Can't make or receive calls

- Check that the mains power is correctly connected.
- The batteries may need recharging.
- Has there been a power cut? If so, place the handset back on the base for ten seconds and try again. If it still doesn't work, disconnect the batteries and mains power for ten minutes, then reconnect and try again.

You have a dial tone, but the phone won't dial out

- If you're connected to a switchboard, check whether you need to dial an access code, see page 40.

Handset doesn't ring

- The ringer volume may be switched off, see page 36.
- Check that the mains power is correctly connected.
- Do Not Disturb may be switched on, see page 22.
- Make sure the handset is registered to the base, see page 50.

No display

- The batteries may be flat, dead or incorrectly inserted.
- Recharge or replace the batteries.

Range icon flashes

- Make sure the handset is registered to the base, see page 50.
- Check that the mains power is correctly connected to the base.
- Check that the handset is within range of the base.
- If the batteries are low, place the handset on the base/charger to recharge.

You hear the busy tone when you press

- Make sure the handset is in range of the base.
- Another handset registered to your BT2100 base may be on the line and Auto Join is switched off, please see page 39.

No Caller Display number/name displayed

- Have you subscribed to a Caller Display service from your network provider? See page 33.
- The caller may have withheld their number.
- Network may not have the callers number information.
- An exact name/number match was not found in your contacts. Check that you've stored the full STD dialling code.

Can't register a handset to a base

- You can register up to five handsets to your BT2100 base and you can register your BT2100 handset to up to four bases. Check that you've not exceeded the limits.
- Check that you've entered the correct system PIN number (default PIN 0000).
- Check that you're at least one metre away from other electrical equipment to avoid interference when registering.

Base unit does not ring, but the lights are on

- Have you connected the telephone line correctly?
- Do Not Disturb may be switched on, see page 22.
- Is the base ringer set to off?
- You may have a faulty line or socket. Try using another socket or line.
If you are a BT customer then please call 0800 800 151 or your network provider if you still have problems.

Buzzing noise on my phone or on other electrical equipment nearby

- Sometimes other electrical equipment can interfere with your BT2100 if it's placed too close. We recommend that you place your BT2100 at least one metre away from electrical appliances or metal obstructions to avoid any risk of interference.

Customer Helpline

If you're still having problems, call us on **0800 145 6789*** or go to **bt.com/producthelp**

General sales enquiries

- BT Residential lines – call **150**. BT Business lines – call **152**.
- For non BT line customers, call **0800 800 150** (residential) or **0800 800 152** (business).
- Additional handsets are available to purchase from the Helpdesk on **0800 145 6789***.

Billing enquiries

Please see the phone number shown on your BT bill.

General information

Important

This equipment is not designed for making emergency phone calls when the power fails. Alternative arrangements should be made for access to emergency services.

This product is intended for connection to analogue public switched telephone networks and private switchboards in the United Kingdom.

Replacing the handset batteries

After a time, you might find that the handset batteries run out of charge more quickly. This is a standard sign of wear and the batteries will need replacing.

1. Open the battery compartment cover.
2. Lift the battery out and remove the batteries.
Replace with two new AAA Ni-MH 550mAh rechargeable batteries.
3. Replace the battery compartment cover.

Caution

Don't immerse batteries in water, throw them into a fire or dispose of them with ordinary domestic refuse.

BT accepts no responsibility for damage caused to your BT2100 by using any other types of batteries.

There is a risk of explosion if incorrect batteries are fitted.

Safety information

- Only use the power supply suitable for the BT2100. Using an unauthorised power supply will invalidate your guarantee and may damage the phone. The item code for the base mains power supply is 066270 . If you've bought a multiple pack, the item code for the charger mains power supply is 066270.
- Use only the approved rechargeable batteries supplied. Spare rechargeable batteries are available from the BT2100 Helpline on 0800 145 6789*.
- Don't open the handset (except to replace the handset batteries) or the base. This could expose you to high voltages or other risks. Contact the Helpline on 0800 145 6789* for all repairs.
- If the keypad is locked, it is still possible to make calls to 999 and 112 emergency numbers by dialling the number then pressing .
- Radio signal transmitted between the handset and base may cause interference to hearing aids.
- It is recommended that advice from a qualified expert be sought before using this product in the vicinity of emergency/intensive care medical equipment.
- It is recommended that if you have a pacemaker fitted you check with a medical expert before using this product.
- Your product may interfere with other electrical equipment, e.g. TV and radio sets, clock/alarms and computers if placed too close.
- It is recommended that you place your product at least one metre away from such appliances to minimise any risk of interference.

- Never dispose of batteries in a fire. There is a serious risk of explosion and/or the release of highly toxic chemicals.

Cleaning

- Clean the handset and base (or charger) with a damp (not wet) cloth, or an anti-static wipe. Never use household polish as this will damage the product. Never use a dry cloth as this may cause a static shock.

Environmental

- Do not expose to direct sunlight.
- The handset may become warm when the batteries are being charged or during prolonged periods of use. This is normal. However, we recommend that to avoid damage you do not place the product on any surface susceptible to heat damage.
- Do not stand your product on carpets or other surfaces which generate fibres, or place it in locations preventing the free flow of air over its surfaces.
- Do not submerge any part of your product in water and do not use it in damp or humid conditions, such as bathrooms.
- Do not expose your product to fire, explosive or other hazardous conditions.
- There is a slight chance your phone could be damaged by an electrical storm. We recommend that you unplug the power and telephone line cord during an electrical storm.

How to recycle your equipment

The symbol shown here and on the product means that the product is classed as electrical or electronic equipment, so DO NOT put it in your normal rubbish bin.



It's all part of the Waste Electrical and Electronic Equipment (WEEE) Directive to recycle products in the best way – to be kinder to the planet, get rid of dangerous things more safely and bury less rubbish in the ground.

You should contact your retailer or supplier for advice on how to dispose of this product in an environmentally friendly way.

Warning

You won't be able to call 999 from this phone if there's a power cut, so make sure you've got another way to call for help in an emergency.

R&TTE Directive & Declaration of Conformity

This product is intended for use within the UK for connection to the public telephone network and compatible switchboards.

This equipment complies with the essential requirements for the Radio Equipment and Telecommunications Terminal Equipment Directive (1999/5/EC).

For a copy of the Declaration of Conformity please refer to bt.com/producthelp

Guarantee

Your BT2100 is guaranteed for 12 months from the date of purchase.

Subject to the terms listed below, the guarantee will provide for the repair of, or at BT's or its agent's discretion, the option to replace the BT2100 or any component thereof, (other than batteries), which is identified as faulty or below standard, or as a result of inferior workmanship or materials. Products over 28 days old from the date of purchase may be replaced with a refurbished or repaired product.

Guarantee conditions

- The guarantee shall only apply to defects that occur within the 12 month guarantee period.
- Proof of purchase is provided.
- The equipment is returned to BT or its agent as instructed.
- This guarantee doesn't cover any faults or defects caused by accidents, misuse, fair wear and tear, neglect, tampering with the equipment, or any attempt at adjustment or repair other than through approved agents.
- This guarantee does not affect your statutory rights.

Within the 12 month guarantee period

Prior to returning your product, please read the Help section beginning on page 54 or contact the BT2100 Helpline on **0800 145 6789***. Additional answers to frequently asked questions are available from **bt.com/producthelp**

In the unlikely event of a defect occurring, the helpdesk will issue a Fault Reference Authorisation (FRA) number and instructions for replacement or repair. Please note you will need the FRA number before returning the product. This does not affect your statutory rights.

Outside of the 12 month guarantee period

If your product needs repair after the guarantee period has ended, the repair must meet the approval requirements for connection to the telephone network. We recommend that you contact BT's recommended repair agent Discount Communications on **0800 980 8999** or a local qualified repairer.

Returning your phone

If the Helpline is unable to remedy your problem they will issue a Fault Reference Authorisation number and ask you to return the product to your original place of purchase. Where possible, pack the product in its original packaging. Please remember to include all parts, including the line cords, power supply units and the original batteries.

Technical information

How many telephones can I have?

All items of telephone equipment have a Ringer Equivalence Number (REN), which is used to calculate the number of items which may be connected to any one telephone line. Your BT2100 has a REN of 1. A total REN of 4 is allowed. If the total REN of 4 is exceeded, the telephones may not ring. With different telephone types there is no guarantee of ringing, even when the REN is less than 4.

Any additional handsets and chargers that you register have a REN of 0.

Connecting to a switchboard

Switchboard compatibility

This telephone may be connected to most types of switchboard, however in the event of any difficulties, consult your switchboard Service Provider.

Recall (R)

Recall is used when connected to certain switchboards/PBXs and some BT Calling Features, or those services available via your network provider. The BT2100 supports time break recall but not earth loop recall.

R&TTE

This product is intended for use within the UK for connection to the public telephone network and compatible switchboards.

This equipment complies with the essential requirements for the Radio Equipment and Telecommunications Terminal Equipment Directive (1999/5/EC).

Declaration of Conformance

Hereby, BT declares that this BT2100 is in compliance with the essential requirements and other relevant provisions of Directive 1999/5/EC.

If you would like a copy of the Declaration of Conformance, please visit bt.com/producthelp

For your records

Date of purchase:

Place of purchase:

For guarantee purposes, proof of purchase is required, so please keep your receipt.

Enter your base system PIN here:

[/ / /]

Enter your remote access PIN here:

[/ / /]

For a Better Future 

We're always looking to make our products last longer and use less power, so we don't have such a big impact on the environment.

To find out about what we are doing, visit bt.com/betterfuture

Offices worldwide

The services described in this publication are subject to availability and may be modified from time to time. Services and equipment are provided subject to British Telecommunications plc's respective standard conditions of contract. Nothing in this publication forms any part of any contract.

© British Telecommunications plc 2015.
Registered Office: 81 Newgate Street, London EC1A 7AJ.
Registered in England No. 1800000.
Printed in China.

Designed by The Art & Design Partnership.

Available in other formats including braille, large print or audio CD.
If you would like a copy, please call 0800 145 6789*.

† UK's No. 1 Phone Brand based on sales. Source GFK RT UK, Landline Phone sales, Volume and Value Sales. Jan 2000-Dec 2014.

* Calls made from within the UK mainland network are free.
Mobile and international call costs may vary.

BT2100 (04/15) Issue 1

